

EG4® 12kPV HYBRID INVERTER

QUICK-START GUIDE

This guide has been created to give the end-user a simple and efficient way to install and commission the 12kPV hybrid inverter.



TABLE OF CONTENTS

1.	TECHNICAL SPECIFICATIONS	1
2.	ABBREVIATIONS.....	3
3.	INVERTER SAFETY.....	4
3.1	SAFETY INSTRUCTIONS.....	4
3.2	IMPORTANT SAFETY NOTIFICATIONS	4
4.	SÉCURITÉ DE L'ONDULEUR.....	6
4.1	INSTRUCTIONS DE SÉCURITÉ	6
4.2	NOTIFICATIONS DE SÉCURITÉ IMPORTANTES.....	6
5.	PACKING LISTS	8
6.	LOCATION SELECTION AND INSTALLATION TOOLS	9
6.1	REQUIREMENTS FOR INSTALLATION LOCATION	9
6.2	RECOMMENDED TOOLS FOR INSTALLATION	9
6.3	INSTALLING THE INVERTER.....	10
6.4	MOUNTING STEPS	10
7.	PRE-WIRE STEPS AND WIRING (BATT, PV, AC).....	11
7.1	WIRE SIZING.....	12
7.2	BATTERY/INVERTER CONNECTION FOR NON-SERVER RACK.....	12
7.3	BATTERY/INVERTER CONNECTION FOR SERVER RACK.....	12
7.4	BMS COMMUNICATIONS.....	13
7.5	PV CONNECTION.....	15
7.6	AC CONNECTION.....	15
8.	SYSTEM START-UP SEQUENCE FOR COMMISSIONING	15
9.	ACCOUNT REGISTRATION	16
10.	FIRMWARE UPDATES.....	16
10.1	INVERTER UPDATE VIA EG4 APP.....	16
10.2	INVERTER UPDATE VIA MONITOR CENTER.....	17
10.3	BATTERY UPDATE.....	17
11.	OPERATION GUIDE	18
11.1	OPERATION MODE AND FUNCTION.....	18
11.2	RAPID SHUTDOWN (RSD).....	21
11.3	LCD DISPLAY AND SETTINGS.....	22
11.4	SETTING PARAMETERS	23
12.	OPERATING MODES	27
12.1	SELF-CONSUMPTION MODE.....	28
12.2	BATTERY BACKUP MODE.....	29
12.3	GRID SELL BACK WITH AC COUPLE	31
13.	DOUBLE CHECK ALL WIRING/VOLTAGES/AMPS	32
14.	FULL SYSTEM START-UP	32
15.	FULL SYSTEM SHUTDOWN.....	32
16.	INVERTER TROUBLESHOOTING	33
16.1	VIEWING INFORMATION AND ALARM FAULT/RECORD.....	33
16.2	REGULAR MAINTENANCE.....	34
16.3	TROUBLESHOOTING BASED ON LCD SCREEN	34
17.	TROUBLESHOOTING WI-FI MODULE	38
17.1	CENTER LIGHT FLASHING	38
17.2	DONGLE RECOVERY	38
18.	WARRANTY INFORMATION.....	42

1. TECHNICAL SPECIFICATIONS

AC INPUT DATA				
NOMINAL AC VOLTAGE	120/240VAC; 120/208VAC (L1/L2/N required)			
FREQUENCY	50/60 Hz			
MAX. AC INPUT POWER	8000W			
MIN. GENERATOR SIZE	>5000W			
MAX. GEN GRID PASSTHROUGH CURRENT	80A 80A			
AC GRID OUTPUT DATA				
MAX. OUTPUT CURRENT	33.3A@240VAC 38.5A@208VAC			
OUTPUT VOLTAGE	120/240VAC; 120/208VAC			
NOMINAL POWER OUTPUT	8000W			
OUTPUT FREQUENCY	50/60 Hz			
POWER FACTOR	0.99 @ Full Load			
REACTIVE POWER ADJUST RANGE	±0.8			
MAX. CONT. LINE WATTAGE	4000W			
PEAK POWER	0.5 s	1 s	1 min	12 min
	16kW	12kW	10kW	8.8kW
OPERATING FREQUENCY	50/60 Hz			
THD (V) @FULL LOAD	<3%			
TRANSFER TIME	Single			Parallel
	20 ms – Default, 10 ms – Selectable			20 ms
PV INPUT DATA				
NUMBER OF MPPTS	2			
INPUTS PER MPPT	2			
MAX. USABLE INPUT CURRENT	25/25A			
	25A per MPPT 41.6A in total			
MAX. SHORT CIRCUIT INPUT CURRENT	31/31A			
DC INPUT VOLTAGE RANGE	100 – 600 VDC			
UNIT STARTUP VOLTAGE	100 VDC			
MPPT OPERATING VOLTAGE RANGE	120 – 500 VDC			
NOMINAL MPPT VOLTAGE	360 VDC			
MAXIMUM UTILIZED SOLAR POWER	12000W			
RECOMMENDED MAXIMUM SOLAR INPUT	15000W			
EFFICIENCY				
MAXIMUM EFFICIENCY (PV TO GRID)	97.5%			
MAXIMUM EFFICIENCY (BATTERY TO GRID)	94%			
CEC WEIGHTED EFFICIENCY	96.4%			
MAXIMUM EFFICIENCY (PV TO BATTERY)	94.5%			
IDLE CONSUMPTION (STANDBY MODE)	<55W			
BATTERY DATA				
COMPATIBLE BATTERY TYPES	Lead-Acid/Lithium			
MAX. CHARGE/DISCHARGE CURRENT	167A@48 VDC			
NOMINAL VOLTAGE	48 VDC			
VOLTAGE RANGE	40 – 60 VDC (Lithium); 40 – 60 VDC (Lead-Acid)			
RECOMMENDED BATTERY CAPACITY PER INVERTER	>200Ah			

GENERAL DATA

MAX. UNITS IN PARALLEL	10
PRODUCT DIMENSIONS (H×W×D)	29.5×20.5×11.2 in (750×520×285 mm)
UNIT WEIGHT	110 lbs. (50 kg)
DESIGN TOPOLOGY	High Frequency - Transformerless
RELATIVE HUMIDITY	0 – 100%
OPERATING ALTITUDE	<2000 m (<6561 ft)
OPERATING AMBIENT TEMPERATURE RANGE	-13°F – 140°F, >113°F Derating (-25°C – 60°C, >45°C Derating)
STORAGE AMBIENT TEMPERATURE RANGE	-13°F – 140°F (-25°C – 60°C)
NOISE EMISSION (TYPICAL)	<50 dB @ 3 ft
LOCKED ROTOR AMPS (LRA)	195A
COMMUNICATION INTERFACE	RS485/Wi-Fi/CAN
STANDARD WARRANTY*	10-year standard warranty
ENCLOSURE RATING	NEMA 4X
SAFETY FEATURES	PV Arc Fault Protection, PV Ground Fault Protection, PV Reverse Polarity Protection, Pole Sensitive Leakage Current Monitoring Unit, Surge Protection Device, Integrated PV Disconnect

STANDARDS AND CERTIFICATIONS

UL1741 SB

CSA C22.2#107.1:2016

CSA C22.2#330:2017 ED 1

HECO SRD-IEEE-1547.1:2020 ED 2

RAPID SHUT DOWN (RSD) NEC 2020:690.12

FCC PART 15, CLASS B

*For information regarding warranty registration on EG4® Electronics products, please navigate to <https://eg4electronics.com/warranty/> and select the corresponding product to begin the registration process.

2. ABBREVIATIONS

- AWG – American Wire Gauge
- A – Amps
- Ah – Amp hour(s)
- AC – Alternating Current
- AFCI – Arc-Fault Circuit Interrupter
- AHJ – Authority Having Jurisdiction
- kAIC – kilo-Amp Interrupting Capability
- ANSI – American National Standards Institute
- BAT – Battery
- BMS – Battery Management System
- COM – Communication
- CT – Current Transformer
- DC – Direct Current
- DIP – Dual In-line Package
- DOD – Depth of Discharge
- EG – Equipment Ground
- EGS – Equipment Grounding System
- EMC – Electromagnetic Compatibility
- EPS – Emergency Power System
- ESS – Energy Storage System
- E-Stop – Emergency Stop
- FCC – Federal Communication Commission
- GE – Grounding Electrode
- GEC – Grounding Electrode Conductor
- GFCI – Ground Fault Circuit Interrupter
- GFDI – Ground Fault Detector/Interrupter
- Imp – Maximum Power Point Current
- IEEE – Institute of Electrical and Electronic Engineers
- IP – Ingress Protection
- I_{sc} – Short-Circuit Current
- In-lbs. – Inch Pounds
- kW – Kilowatt
- kWh – Kilowatt-hour
- LCD – Liquid Crystal Display
- LFP – Lithium Iron Phosphate
- L1 – Line 1
- L2 – Line 2
- mm – Millimeters
- MPPT – Maximum Power Point Tracking
- mV – Millivolt
- N – Neutral
- NEC – National Electric Code
- NEMA – National Electrical Manufacturers Association
- NFPA – National Fire Prevention Association
- Nm – Newton Meters
- NOCT – Normal Operating Cell Temperature
- PC – Personal Computer
- PCB – Printed Circuit Board
- PE – Protective Earth
- PPE – Personal Protective Equipment
- PV – Photovoltaic
- RSD – Rapid Shut Down
- SCC – Standards Council of Canada
- SOC – State of Charge
- STC – Standard Testing Conditions
- UL – Underwriters Laboratories
- UPS – Uninterrupted Power Supply
- V – Volts
- VOC – Open-Circuit Voltage
- VMP – Voltage Maximum Power

3. INVERTER SAFETY

3.1 SAFETY INSTRUCTIONS

International safety regulations have been strictly observed in the design and testing of the inverter. Before beginning any work, carefully read all safety instructions, and always observe them when working on or with the inverter. The installation must follow all applicable national or local standards and regulations.

Incorrect installation may cause:

- Injury or death to the installer, operator or third party
- Damage to the inverter or other attached equipment

3.2 IMPORTANT SAFETY NOTIFICATIONS



DANGER: *Hazardous Voltage Circuits!*

There are various safety concerns that must be carefully observed before, during, and after the installation, as well as during future operation and maintenance. The following are important safety notifications for the installer and any end users of this product under normal operating conditions.

1. **Beware of high PV voltage.** Install an external DC disconnect switch or breaker and ensure it is in the “off” or “open” position before installing or working on the inverter. Use a voltmeter to confirm there is no DC voltage present to avoid electric shock.
2. **Beware of high grid voltage.** Ensure the AC switch and/or AC breaker are in the “off” or “open” position before installing or working on the inverter. Use a voltmeter to confirm there is no voltage present to avoid electric shock.
3. **Beware of high battery current.** Ensure that the battery module breakers and/or on/off switches are in the “open” or “off” position before installing or working on the inverter. Use a voltmeter to confirm there is no DC voltage present to avoid electric shock.
4. **Do not open the inverter while it is operating to avoid electric shock and damage from live voltage and current within the system.**
5. Do not make any connections or disconnections (PV, battery, grid, communication, etc.) while the inverter is operating.
6. An installer should make sure to be well protected by reasonable and professional insulative equipment [e.g., personal protective equipment (PPE)].
7. Before installing, operating, or maintaining the system, it is important to inspect all existing wiring to ensure that it meets the appropriate specifications and conditions for use.
8. Ensure that the PV, battery, and grid connections to the inverter are secure and proper to prevent damage or injuries caused by improper installation.
9. Some components of the system can be very heavy. Be sure to utilize team-lift among other safe lifting techniques throughout the installation.



WARNING: TO REDUCE THE RISK OF INJURY, READ ALL INSTRUCTIONS!

All work on this product (system design, installation, operation, setting, configuration, and maintenance) must be carried out by qualified personnel. To reduce the risk of electric shock, do not perform any servicing other than those specified in the operating instructions unless qualified to do so.

1. Read all instructions before installing. For electrical work, follow all local and national wiring standards, regulations, and these installation instructions.
2. Make sure the inverter is properly grounded. All wiring should be in accordance with the National Electrical Code (NEC), ANSI/NFPA 70.
3. The inverter and system can inter-connect with the utility grid only if the utility provider permits. Consult with the local AHJ (Authority Having Jurisdiction) before installing this product for any additional regulations and requirements for the immediate area.
4. All warning labels and nameplates on the inverter should be clearly visible and must not be removed or covered.
5. The installer should consider the safety of future users when choosing the inverter's correct position and location as specified in this manual.
6. Keep children from touching or misusing the inverter and relevant systems.
7. **Beware!** The inverter and some parts of the system can be hot when in use. Do not touch the inverter's surface or most of the parts when they are operating. During operation, only the LCD and buttons should be touched.



WARNING!

Cancer and Reproductive Harm – See www.P65Warnings.ca.gov for more details.

DISCLAIMER

EG4 reserves the right to make changes to the material herein at any time without notice.

Please refer to www.eg4electronics.com for the most updated version of our manuals/spec sheets.

4. SÉCURITÉ DE L'ONDULEUR

4.1 INSTRUCTIONS DE SÉCURITÉ

Les réglementations internationales de sécurité ont été strictement observées lors de la conception et des tests de l'onduleur. Avant de commencer tout travail, lisez attentivement toutes les instructions de sécurité et respectez-les toujours lorsque vous travaillez sur ou avec l'onduleur. L'installation doit suivre toutes les normes et réglementations nationales ou locales applicables. Consultez l'autorité locale compétente et/ou le fournisseur d'électricité pour obtenir les permis et autorisations nécessaires avant l'installation.

Une installation incorrecte peut causer:

- Des blessures ou la mort de l'installateur, de l'opérateur ou d'un tiers
- Des dommages à l'onduleur ou à d'autres équipements connectés

4.2 NOTIFICATIONS DE SÉCURITÉ IMPORTANTES



DANGER: *Circuits à haute tension!*

Il y a divers problèmes de sécurité qui doivent être soigneusement observés avant, pendant et après l'installation, ainsi que pendant l'exploitation et la maintenance futures. Les notifications de sécurité suivantes sont importantes pour l'installateur et tout utilisateur final de ce produit dans des conditions normales de fonctionnement.

1. **Attention à la haute tension PV.** Installez un interrupteur ou disjoncteur externe de déconnexion DC et assurez-vous qu'il est en position "off" ou "ouvert" avant d'installer ou de travailler sur l'onduleur. Utilisez un voltmètre pour confirmer qu'il n'y a pas de tension DC présente afin d'éviter les chocs électriques.
2. **Attention à la haute tension du réseau.** Assurez-vous que l'interrupteur AC et/ou le disjoncteur AC sont en position "off" ou "ouvert" avant d'installer ou de travailler sur l'onduleur. Utilisez un voltmètre pour confirmer qu'il n'y a pas de tension présente afin d'éviter les chocs électriques.
3. **Attention au courant élevé de la batterie.** Assurez-vous que les disjoncteurs des modules de batterie et/ou les interrupteurs on/off sont en position "ouvert" ou "off" avant d'installer ou de travailler sur l'onduleur. Utilisez un voltmètre pour confirmer qu'il n'y a pas de tension DC présente afin d'éviter les chocs électriques.
4. **Ne pas ouvrir l'onduleur pendant qu'il fonctionne pour éviter les chocs électriques et les dommages dus à la tension et au courant en direct dans le système.**
5. Ne pas effectuer de connexions ou de déconnexions (PV, batterie, réseau, communication, etc.) pendant que l'onduleur fonctionne.
6. Un installateur doit s'assurer d'être bien protégé par un équipement isolant raisonnable et professionnel (par exemple, équipement de protection individuelle (EPI)).
7. Avant d'installer, d'exploiter ou de maintenir le système, il est important d'inspecter tous les câblages existants pour s'assurer qu'ils répondent aux spécifications et conditions appropriées pour l'utilisation.
8. Assurez-vous que les connexions PV, batterie et réseau à l'onduleur sont sécurisées et appropriées pour éviter les dommages ou les blessures causés par une installation incorrecte.
9. Certains composants du système peuvent être très lourds. Assurez-vous d'utiliser des techniques de levage en équipe parmi d'autres techniques de levage sûres tout au long de l'installation.



AVERTISSEMENT : POUR RÉDUIRE LE RISQUE DE BLESSURE, LISEZ TOUTES LES INSTRUCTIONS !

Tous les travaux sur ce produit (conception du système, installation, exploitation, réglage, configuration et maintenance) doivent être effectués par du personnel qualifié. Pour réduire le risque de choc électrique, ne réalisez aucun entretien autre que ceux spécifiés dans les instructions de fonctionnement, sauf si vous êtes qualifié pour le faire.

10. Lisez toutes les instructions avant d'installer. Pour les travaux électriques, suivez toutes les normes et réglementations locales et nationales de câblage, ainsi que ces instructions d'installation.
11. Assurez-vous que l'onduleur est correctement mis à la terre. Tous les câblages doivent être conformes au Code National de l'Électricité (NEC), ANSI/NFPA 70.
12. L'onduleur et le système peuvent se connecter au réseau électrique uniquement si le fournisseur d'électricité le permet. Consultez l'autorité locale compétente avant d'installer ce produit pour toute réglementation et exigence supplémentaire pour la zone immédiate.
13. Toutes les étiquettes d'avertissement et les plaques signalétiques sur l'onduleur doivent être clairement visibles et ne doivent pas être retirées ou couvertes.
14. L'installateur doit tenir compte de la sécurité des futurs utilisateurs lors du choix de la position et de l'emplacement corrects de l'onduleur, comme spécifié dans ce manuel.
15. Empêchez les enfants de toucher ou de mal utiliser l'onduleur et les systèmes pertinents.
16. **Attention !** L'onduleur et certaines parties du système peuvent être chauds lorsqu'ils sont utilisés. Ne touchez pas la surface de l'onduleur ou la plupart des pièces lorsqu'elles fonctionnent. Pendant le fonctionnement, seuls l'écran LCD et les boutons doivent être touchés.



AVERTISSEMENT !

Cancer et dommages reproductifs – Voir www.P65Warnings.ca.gov pour plus de détails.







DISCLAIMER

EG4® se réserve le droit de modifier le contenu de ce document à tout moment sans préavis. Veuillez consulter www.eg4electronics.com pour la version la plus récente de nos manuels/fiches techniques.

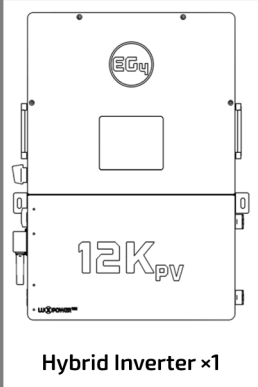
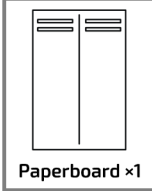
5. PACKING LISTS

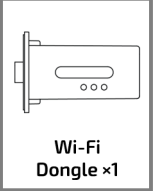
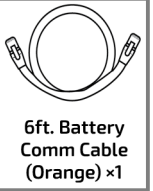
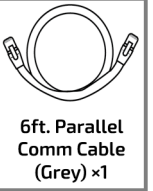
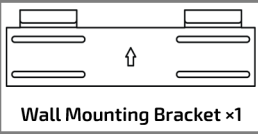
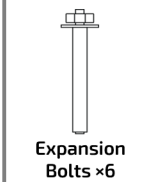
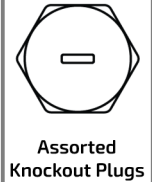
The items listed below will arrive with each product shipment:

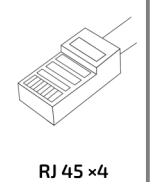
12kPV:

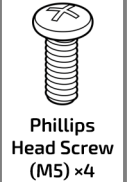
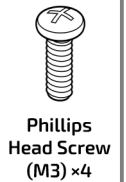
 <p>Hybrid Inverter ×1</p>	 <p>Paperboard ×1</p>	 <p>1" CT ×2</p>	 <p>Wi-Fi Dongle ×1</p>	 <p>6ft. Battery Comm Cable (Orange) ×1</p>	 <p>6ft. Parallel Comm Cable (Grey) ×1</p>	 <p>Wall Mounting Bracket ×1</p>	
	 <p>Expansion Bolts ×6</p>	 <p>Assorted Knockout Plugs</p>	 <p>L-Bracket ×2</p>	 <p>RJ 45 ×4</p>	 <p>Keys ×2</p>	 <p>Phillips Head Screw (M5) ×4</p>	 <p>Phillips Head Screw (M3) ×4</p>

6. LOCATION SELECTION AND INSTALLATION TOOLS

6.1 REQUIREMENTS FOR INSTALLATION LOCATION

1. The mounting wall must be strong enough to bear the weight of the inverter.
2. Maintain the minimum clearance of 4.9 in. (125 mm) between the inverter and other components of the system to allow adequate heat dissipation.



NOTE:

When mounting the inverter, ensure there is enough space on either side of the unit to allow access to all components of the system such as the RSD switch, Wi-Fi dongle, and door latches.

3. Never position the inverter in direct sunlight. Ensure the site is well shaded or placed in a shed to protect the inverter and LCD from excessive UV exposure.
4. Ensure the inverter is mounted upright. Do not mount the inverter at a $>90^\circ$ angle, or upside down. See image below.

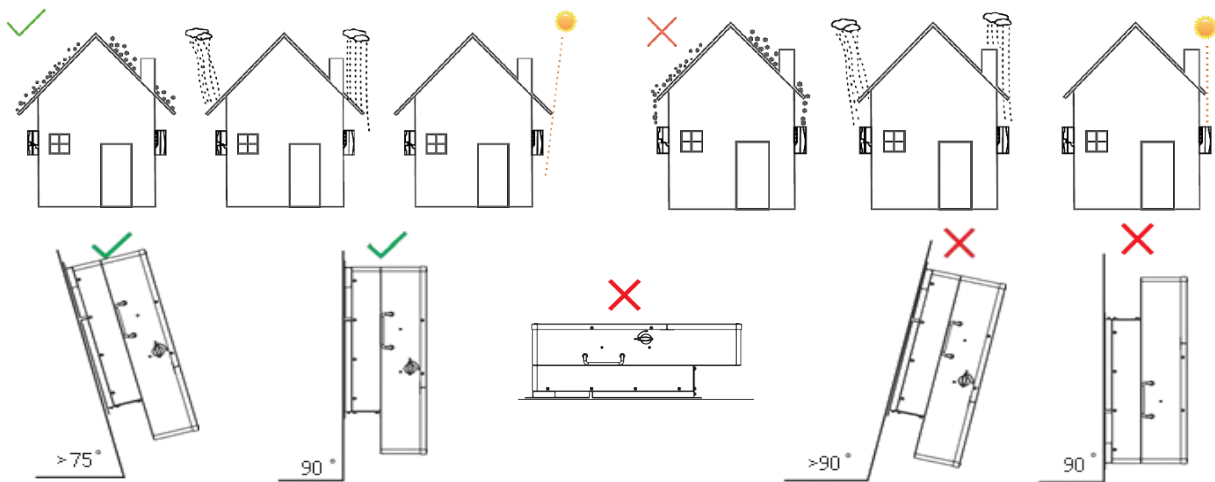

6.2 RECOMMENDED TOOLS FOR INSTALLATION

The following list of tools are not included with purchase, but may be required to complete the installation process:

- Hand truck with all terrain tires
- Tape measure
- Drill and drill bits (5/16")
- M8 Hex wrench/socket
- M5 Hex wrench/socket
- Torque wrench
- Multimeter
- Lineman pliers, rabbit ears or side cutters
- Wire strippers
- Channel locks
- Medium Phillips head screwdriver
- 13 mm or 1/2" socket for lag screws
- 14 mm or 9/16" socket for anchors

6.3 INSTALLING THE INVERTER

The 12kPV is designed to be wall mounted using a wall mounting bracket. The mounting location must be a vertical, solid mounting surface, such as concrete or brick, and be able to withstand the weight of the unit. The surface must be made of non-combustible material. The slots on the mounting bracket can accommodate various stud spacings from 12 in. (305 mm) to 16 in. (406 mm). See image below.

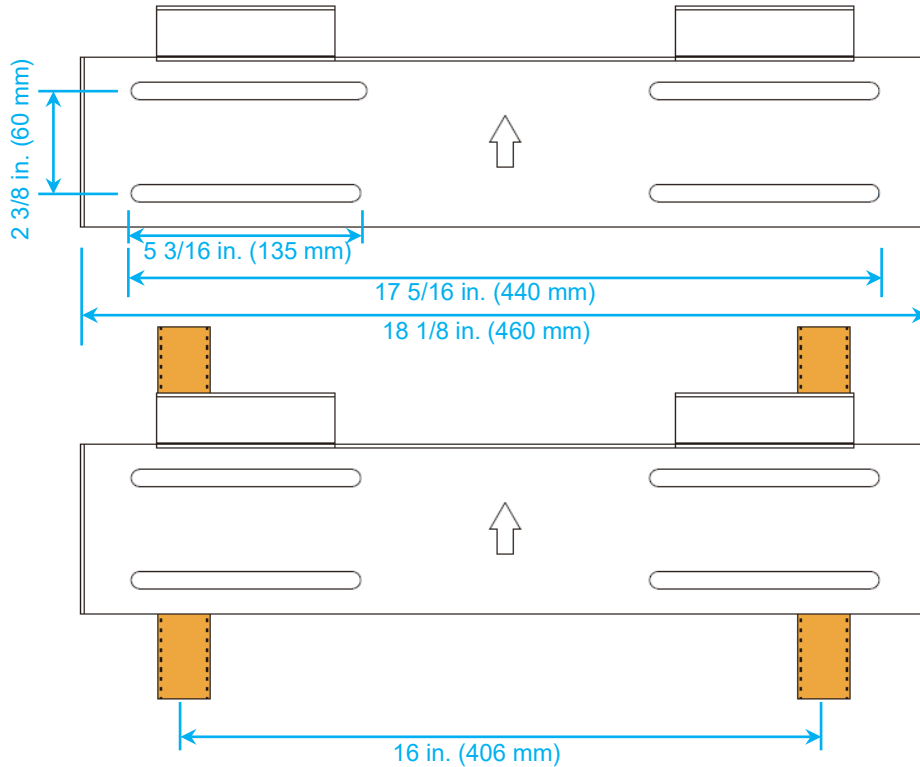

6.4 MOUNTING STEPS

Follow the steps below if mounting on brick or concrete:

1. Using the included template, mark the hole positions for the mounting bracket.
2. Drill four 5/16 in. diameter holes, ensuring the holes are deeper than 2 in.
3. Insert the expansion bolts into the drilled holes and tighten.
4. Use the included nuts and washers, packaged together with the expansion bolts, to secure the wall-mount bracket to the wall.
5. Using the team-lift technique, hang the inverter on the wall-mount bracket and lock it to the wall with two self-tapping screws (not included) and the included L-brackets.

For mounting on concrete board with wooden studs:

1. To ensure correct mounting, follow steps 1 and 2 above before proceeding.
2. Fasten the mounting bracket to the studs with four heavy duty wood screws.
3. Using the team-lift technique, hang the inverter on the wall-mount bracket and lock it to the wall with two self-tapping screws (not included) and the included L-brackets.



NOTE:

Wood screws and self-tapping screws are not included in the shipment. Installers will need to acquire all necessary screws before installation.

7. PRE-WIRE STEPS AND WIRING (BATT, PV, AC)

Back View of the Cable Box Knockouts

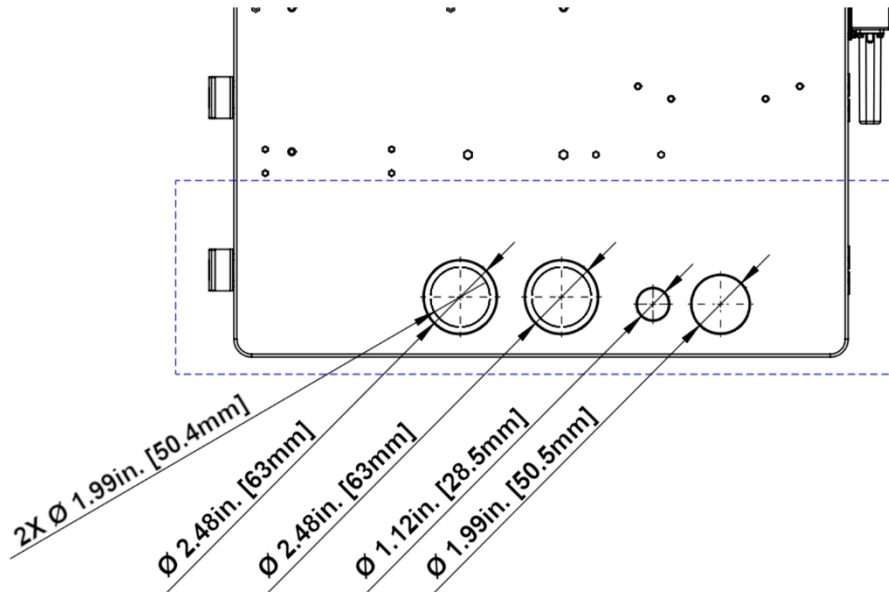

Bottom View of Cable Box Knockouts

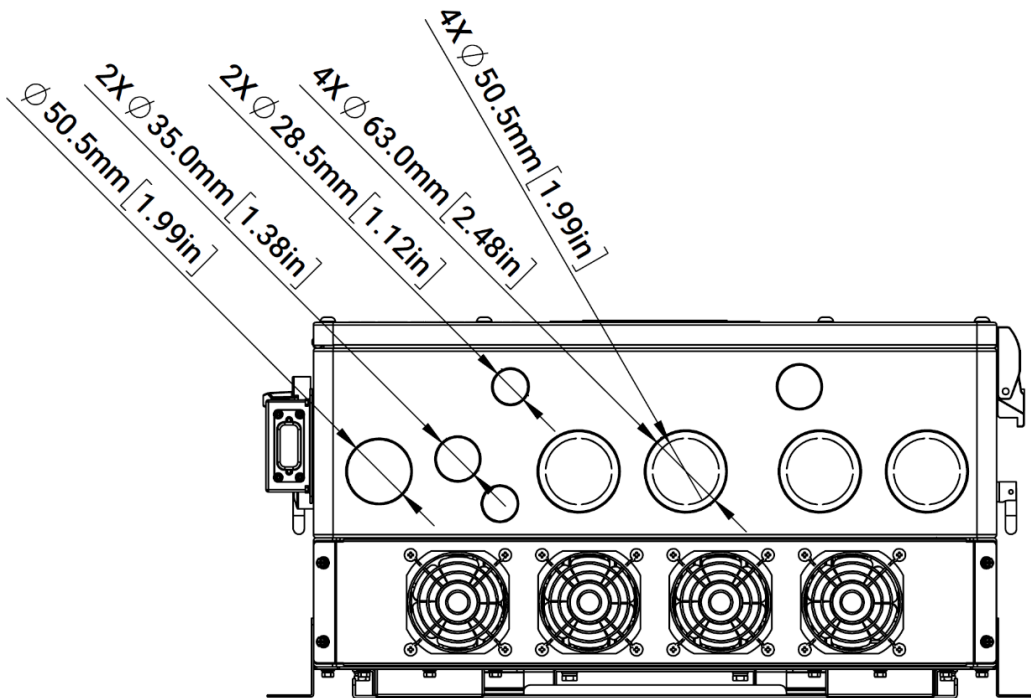

U.S. NOM. TRADE SIZE	ACTUAL KNOCKOUT SIZE
1/2 in.	0.88 in. (22.2 mm)
3/4 in.	1.12 in. (28.5 mm)
1 in.	1.38 in. (35 mm)
1 1/4 in.	1.73 in. (44 mm)
1 1/2 in.	1.99 in. (50.5 mm)
2 in.	2.48 in. (63 mm)

7.1 WIRE SIZING

Reference the tables below for wire size and torque recommendations depending on the type of wire and connection.

Battery Wire Sizing

CABLE SIZE	MAX. DISTANCE	TORQUE VALUES
4/0 AWG (107 mm ²)	10 ft.	Max. 22.9 ft-lbs. (31.1Nm)
250 Kcmil (127 mm ²)	20 ft.	Max. 22.9 ft-lbs. (31.1Nm)

PV Wire Sizing

CABLE SIZE	MINIMUM INSULATOR VOLTAGE
10 AWG – 6 AWG (Max.) (6 mm ² – 16 mm ²)	600V

AC Wire Sizing

TERMINAL CONNECTION	CABLE SIZE	TORQUE VALUES
GRID	Max. 4 AWG (21.2 mm ²)	17.7 in-lbs. (2Nm)
GEN	Max. 4 AWG (21.2 mm ²)	17.7 in-lbs. (2Nm)
LOAD	Max. 4 AWG (21.2 mm ²)	17.7 in-lbs. (2Nm)

7.2 BATTERY/INVERTER CONNECTION FOR NON-SERVER RACK

1. Ensure all circuit breakers are open (off). Use a multimeter to test the wires and terminals for voltage. If no voltage is present, proceed to the next step.
2. Route the battery power cables, ensuring cables are long enough to span the distance between battery and inverter terminals, without making any connections.
3. Secure a conduit fitting to the enclosure using a counter nut.
4. Connect the battery positive and negative cables to the inverter's mechanical lugs using an M8 hex wrench, torquing to a maximum value of 22.9 ft-lbs. (31.1 Nm).



NOTE:

Conduit fittings and counter nuts are not included with purchase. Installers will need to acquire all necessary conduit accessories before installation.

7.3 BATTERY/INVERTER CONNECTION FOR SERVER RACK

The recommended installation practice with server rack batteries requires the use of external busbars or battery cabinets with busbars. Follow the steps below to install the batteries to an external busbar:

1. Ensure all circuit breakers are open (off). Use a multimeter to test the wires and terminals for voltage. If no voltage is present, proceed to the next step.
2. Remove the M8 terminal bolts. Install the power cables (positive and negative) to the battery terminals. Reseat the M8 bolts once the cables are in place, torquing to a maximum value of 70 in-lbs. (7.9Nm).
3. Install the power cables to the external busbar torquing to a maximum value of 15 ft-lbs. (20.3Nm).
4. Install the power cables from the external busbar to the inverter, torquing to a maximum value of 22.9 ft-lbs. (31.1Nm).



IMPORTANT!

Size the battery cables going from external busbar to inverter accordingly! Refer to an NEC ampacity chart for further information.

7.4 BMS COMMUNICATIONS

EG4® batteries interface with an inverter by designating a “Master” battery (DIP switch ID No. 1). Depending on the model of battery, the available ID codes range from 1 – 64 (1 – 16 for LifePower4). The battery will connect directly to the inverter (*shown below*) via an RS485 battery communications cable or a standard CAT 5, CAT 5e, or CAT 6 cable for closed loop communications with supported non-EG4 inverters using CAN bus protocol.

The table below shows the communication protocol for the inverter. For battery specific pinouts, refer to the battery user manual.

PIN #		1	2	3	4	5	6	7	8
CAN	Pin	X	X	X	BMS_CAN H	BMS_CAN L	X	X	X
RS485	Description	BMS_485 B	BMS_485 A	X	X	X	X	X	X

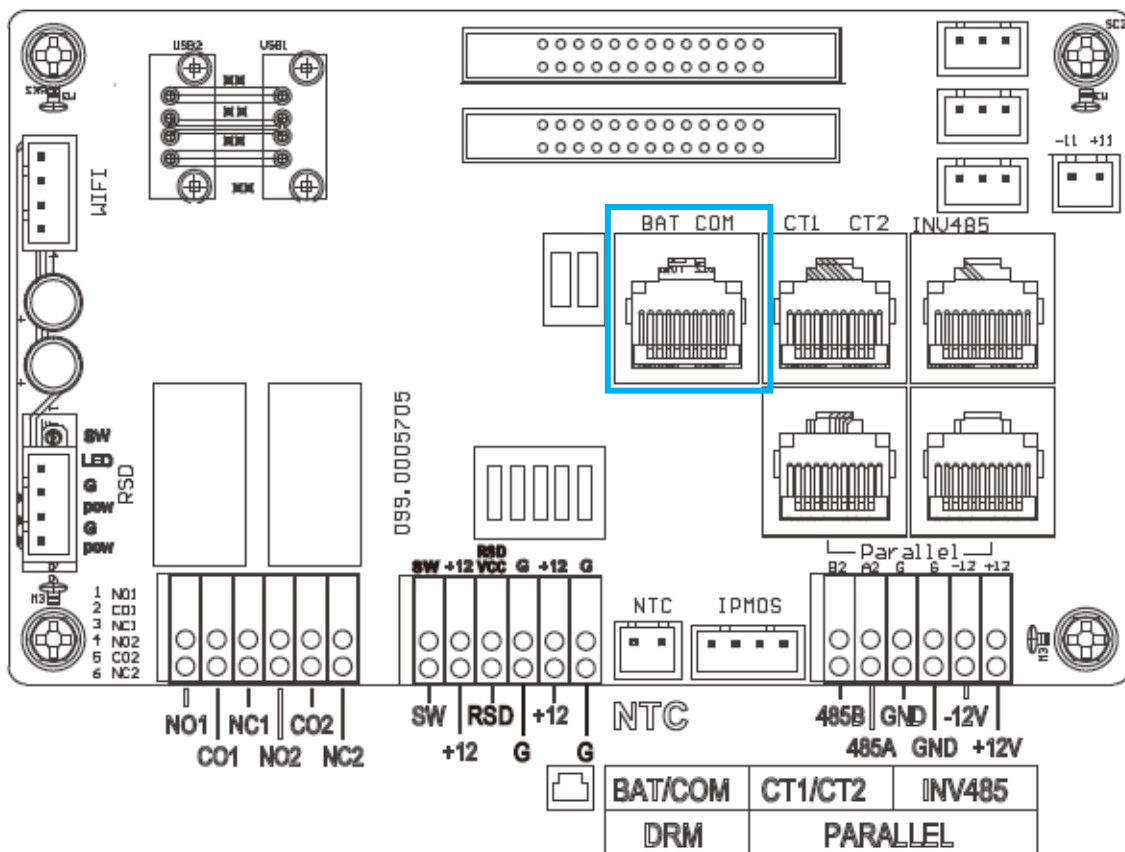



Closed Loop Communications: WallMount, LL-S, LL-V2 & LifePower4 V2



IMPORTANT:

Only the master battery (Address 1) must be set to the inverter protocol; all other batteries must have unique addresses starting at address 2 and ascending in chronological order. The CAN port of the master battery must be connected to the inverter's (or communication device's) BMS communication port.

CAN PROTOCOL LIST	
PROTOCOL #	MANUFACTURER
P01-EG4/LUX	EG4/LUX
P02-GRW	Growatt
P03-SLK	Sol-Ark
P04-DY	Deye
P05-MGR	Megarevo
P06-VCT	Victron
P07-LUX	Luxpower
P08-SMA	SMA

1. Power off all battery DC breakers and BMS power buttons.
2. The inverter protocol can only be changed with the master battery temporarily set to address 64 (all switches ON.) See *image*. 
3. After the dipswitch is changed, reset the battery using the BMS power button for the settings to take effect.
4. On the master battery, press and hold the "Return"  key for 5 seconds and
5. release to enter the "Protocol Setting" menu.
6. Select the CAN Protocol. Select EG4/LUX for closed loop communications.
7. Change the master DIP switch back to address 1 for inverter communications. Reset the BMS to register the change. See *image*. 

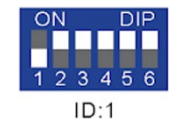
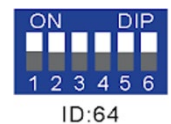

NOTE:

To achieve closed loop communications between LifePower4 batteries and the 12kPV inverter, a battery firmware update is required. Navigate to eg4electronics.com or contact the distributor to locate this file.

Closed Loop Communications: LifePower4

1. Set the dipswitches on the master battery to address "0." See *image*. 
2. Set the following battery dipswitches in ascending order to ensure there are no matching addresses.
3. Reset the battery BMS using the built-in circuit breaker.



7.5 PV CONNECTION

1. Ensure all circuit breakers are open (off). Use a multimeter to test the wires and terminals for voltage. If no voltage is present, proceed to the next step.
2. Strip 1/2 in. – 2/3 in. (13 – 17 mm) insulation from the PV wires.
3. Insert the conduit fitting into the opening for the PV connection and tighten it from the inside using a counter nut.
4. Route the PV wires through the conduit fitting and into the inverter.
5. Secure the PV wires into the terminals. Verify the connection by lightly tugging on the wires.



NOTE:

If using fine stranded wire, use ferrules to secure the connection.

7.6 AC CONNECTION

1. Ensure all circuit breakers are open (off). Use a multimeter to test the wires and terminals for voltage. If no voltage is present, proceed to the next step.
2. Strip 3/5 – 4/5 in. (15 – 20 mm) insulation from cables (If using stranded wire, use wire ferrules).
3. Secure a conduit fitting to the enclosure using the counter nut of the fitting.
4. Fasten the GRID and LOAD cables to the respective terminals (GRID= AC Input, LOAD = AC Output) using a Phillips head screwdriver, torquing to 17.7 in-lbs. (2Nm).
5. Secure conduit to the conduit fitting.

For more additional information regarding physical power connections and paralleling, scan the QR code to navigate to the Connections and Paralleling guide.

CONNECTIONS & PARALLELING GUIDE



8. SYSTEM START-UP SEQUENCE FOR COMMISSIONING

Follow the steps below to turn the system on to disable output while finishing commissioning:

1. Ensure the LOAD breaker is open (off). Use a multimeter to test all components for voltage. If no voltage is present, proceed to the next step.
2. If equipped, close (turn on) the external DC breaker between the battery and inverter. Turn on the “BAT” breaker located in the cable box of the inverter and then power on the battery system.
3. Ensure the PV string voltages are within the operating parameters using a multimeter. Upon confirmation, turn on (close) the PV isolator switch between the inverter and the panel array.
4. Turn on (close) the PV isolator switch on the side of the unit.
5. Make sure Steps 1 and 2 are accomplished before turning on the grid power or generator breaker.
6. Ensure the LOAD breaker is open (off) before proceeding to account registration.

Once the steps above are completed, the system will be in the proper state allowing for registry changes.



NOTE:

Steps listed in section 7 are for a single inverter. If using two or more inverters, refer to the EG4® 12kPV Connections & Paralleling Guide.

9. ACCOUNT REGISTRATION

Before using the EG4® Monitoring Center, an account must be registered. Follow the steps outlined below for account creating and linking:

1. Register the account:
 - a. Visit <https://monitor.eg4electronics.com/> or download the “EG4 Monitor” app to register for an end-user account.
2. When registering the account, provide the following information:
 - b. Customer code: This is the code for a distributor or installer. Contact the distributor or installer to obtain this code.
 - c. Dongle SN: The serial number is attached to the shell on the sticker.
 - d. Dongle PIN: The PIN is attached to the shell on the sticker.
3. Set the Wi-Fi Password:
 - e. Ensure the inverter is powered on and plug in the Wi-Fi dongle into the dongle port.
 - f. Wait until the “INV” LED on the module is solid. Once solid, connect the mobile device to the dongle’s Wi-Fi hotspot. The hotspot will be named the same as the SN of the module.
 - g. Open the app and click “DONGLE CONNECT.”
Select the yellow “Refresh” button to display a full list of available networks. Select the home Wi-Fi network and enter the password.
 - h. After selecting “Home Wi-Fi Connect,” the dongle will reset. Once all three LED lights are solid the inverter has successfully connected to the network.

DEVICE MONITORING & SETTINGS GUIDE



10. FIRMWARE UPDATES

Before commissioning the system, ensure all components’ firmware is fully up to date. There are two different methods for updating the inverter’s firmware. The two methods are listed below:



NOTE:

Contact the distributor to ensure the latest firmware files are applied.

10.1 INVERTER UPDATE VIA EG4 APP

1. Open the EG4 Electronics app on a mobile device and select the “DOWNLOAD FIRMWARE” button.
2. Select the correct inverter model, then select “DOWNLOAD” on the right-hand side to download the file to a mobile device.
3. With the app still running, go to the mobile device’s Wi-Fi settings. Connect the mobile device to the Wi-Fi dongle’s network. The dongle’s network ID will be the same as the dongle’s Serial Number.
4. Return to the home screen of the app and select “LOCAL CONNECT.” Select the “Set” button on the right-hand side of the app and proceed to the next step.
5. Swipe upward on the phone screen until the “Update Firmware” button is visible at the bottom of the app’s display.
6. Choose the correct installation package in the dropdown box and click “UPDATE FIRMWARE” to begin the update process.

10.2 INVERTER UPDATE VIA MONITOR CENTER

1. Log in to the EG4® Monitor Center. Select “Maintenance” and then select “Remote Update”.
2. Choose the inverter needing the update by SN and select “Standard Update.” The Monitor Center will begin updating both firmware files for the inverter. The latest version of the firmware will be displayed in the bottom-right window.

The screenshot shows the EG4 Monitor Center interface. The 'Maintenance' tab is selected. Under 'Remote Set', the 'Remote Update' button is highlighted. Below it is a table of inverters:

Serial number	Dongle	Firmware version	Connect Status	Action	
1	3122670040	BG32601604	FAAB-1B1C	Connected	Standard Update
2	3122670120	BG32603044	FAAB-1B1D	Connected	Standard Update
3	3192670235	BG32603044	FAAB-1B18	Lost	Standard Update
4	3192670620	BA32800192	FAAB-1B1C	Connected	Standard Update
5	3464660443	BA32800157	FAAB-1B1C	Connected	Standard Update
6	3463740076	BG32604514	ccaa-16080B	Lost	Standard Update
7	4053740029	BA32003461	cCaa-1B676F	Lost	Standard Update
8	4053740560	BJ40171033	cCaa-1B676F	Connected	Standard Update
9	4083700245	BA32404475	cCaa-1B656D	Lost	Standard Update
10	3182670282	BG32604049	FAAB-1A19	Lost	Standard Update
11	3262720291	BA30100082	EAAB-1515	Lost	Standard Update
12	3383740073	BA30100082	cCaa-1B676F	Lost	Standard Update
13	3464660718	BG32604049	FAAB-1D1D	Connected	Standard Update
14	3520830002	BJ40170014	EAAB-191A	Lost	Standard Update
15	3520830003	BJ40871605	EAAB-1B1B	Lost	Standard Update
16	4054850052	DK40670006	IAAB-0900	Lost	Standard Update
17	4054850101	DK40670093	IAAB-0900	Lost	Standard Update
18	4174830040	BJ40871605	eAAB-1D1D	Lost	Standard Update
19	4174830043	BJ40170435	eAAB-1D1D	Connected	Standard Update
20	TEST12K001	BA30100082	FAAB-1D1D	Lost	Standard Update
21	3122670191	BJ40170045	FAAB-1919	Lost	Standard Update
22	4114830082	BJ40170045	eAAB-1919	Lost	Standard Update



NOTE:

While performing the update, make sure the inverter stays powered on throughout the entire process to ensure the update goes through successfully.

10.3 BATTERY UPDATE

To update the firmware on the battery, navigate to EG4electronics.com to find the latest files. Included in the downloaded file are two guides in PDF format to walk through the steps of each update. **Follow the guides to avoid soft-bricking the battery BMS!**

11. OPERATION GUIDE

11.1 OPERATION MODE AND FUNCTION

Self-Consumption Mode

Self-Consumption mode will be the default mode upon start-up. In this mode, the order of priority for powering loads is Solar>Battery>Grid. The order of priority for solar power usage is Load>Battery.

Application Scenarios

Self-Consumption mode will increase the consumption rate of solar power and reduce energy bills.

Related Settings

Effective when Charge Priority, AC Charge, and Forced Discharge are disabled.

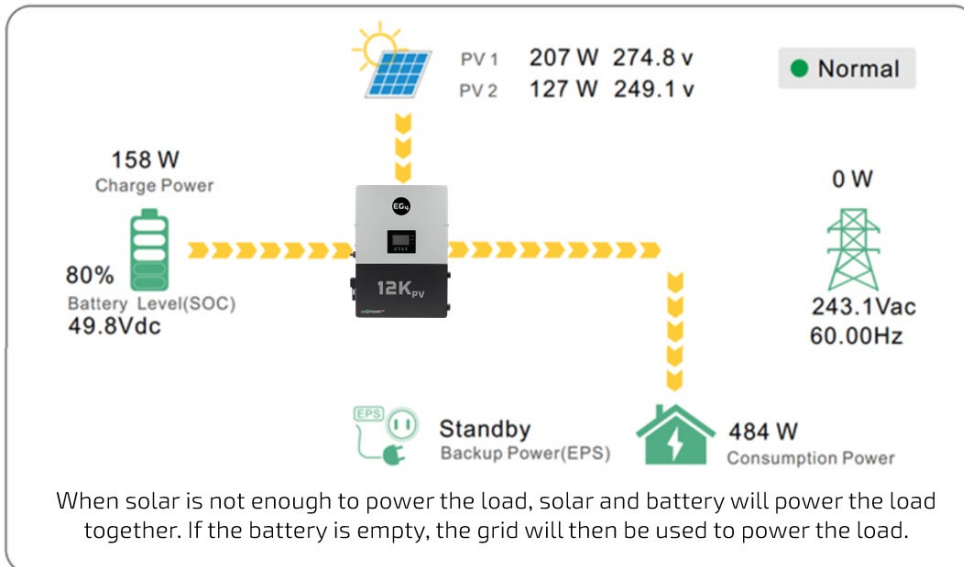
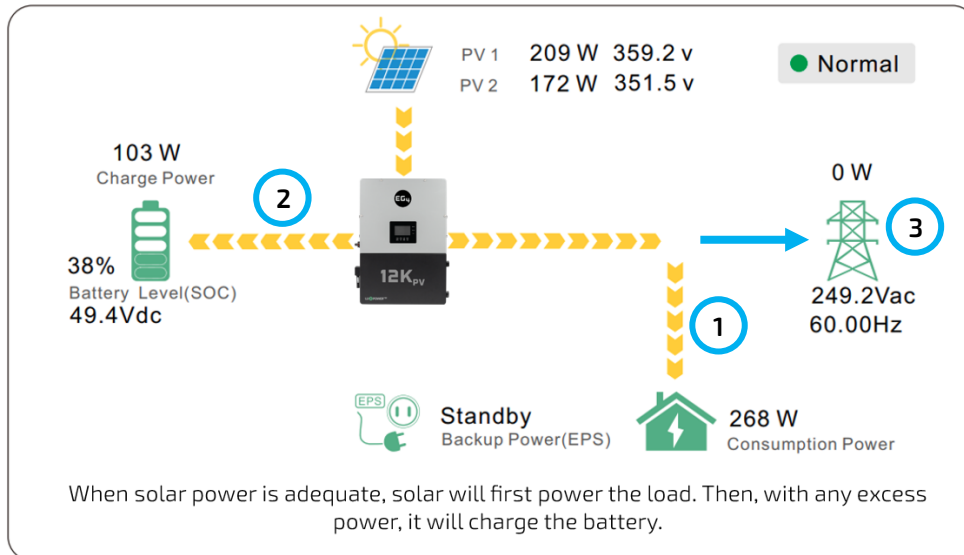

Charge First Mode

The order of priority for solar power usage will be Battery>Load>Grid. During the charge first period, loads are first supplied power from the grid. If there is excess solar power after charging batteries, the excess solar will power the loads along with grid power.

Application Scenarios

When users want solar power to charge batteries, and the grid is used to power loads.

Related Settings

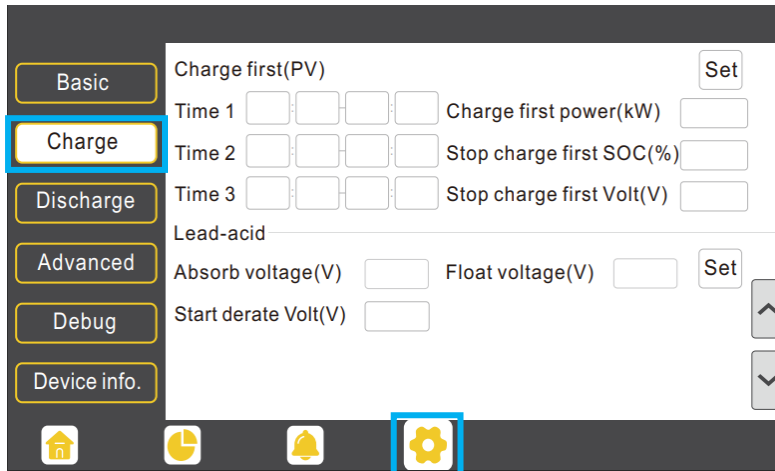

Example

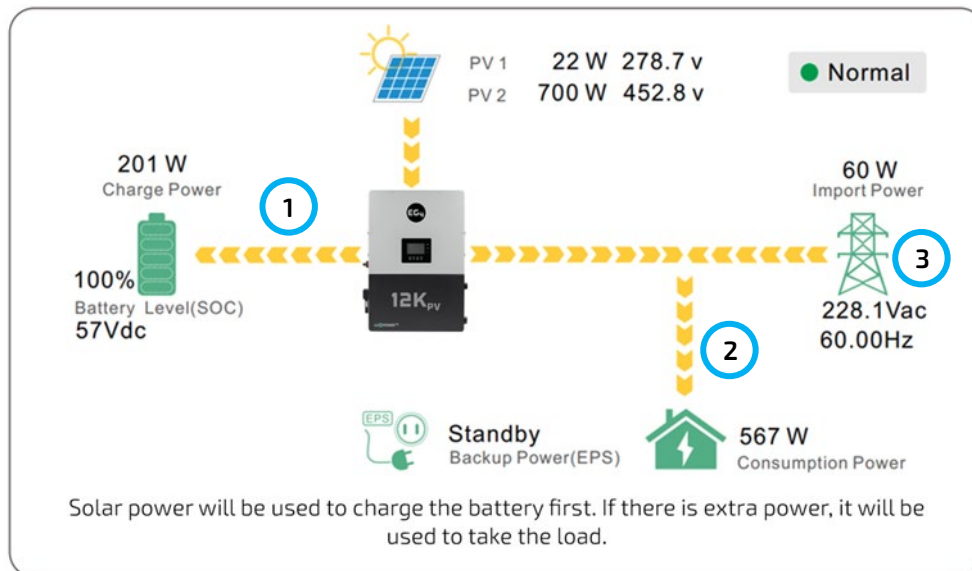

AC Charge Mode

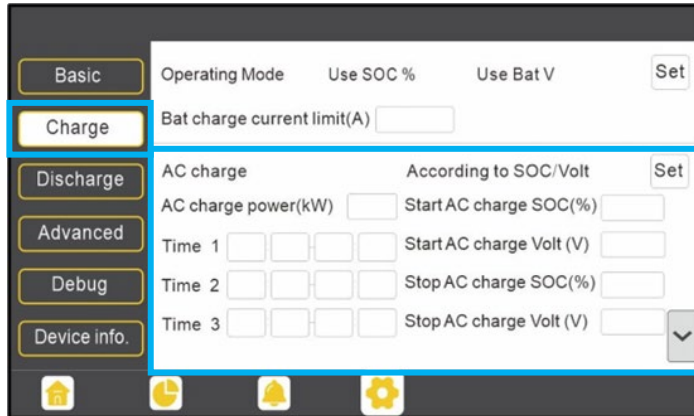

AC charge mode

Users can charge batteries with grid power when electricity prices are low, then use battery power run loads or export to the grid when electricity prices are high.

Application Scenarios

When users have a Time of Use (TOU) rate plan.

Related Settings (see image to left)

Grid Peak-Shaving

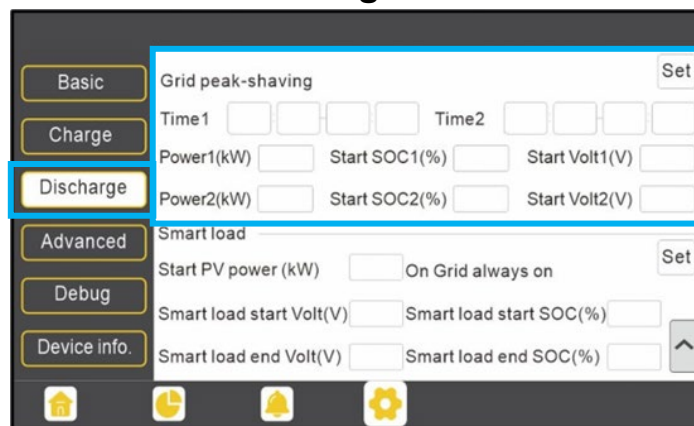

Grid peak-shaving and peak-shaving power (kW):

Used to set the maximum power that the inverter will draw from the grid. The minimum setting value is 0.2kW.

Smart Load Function

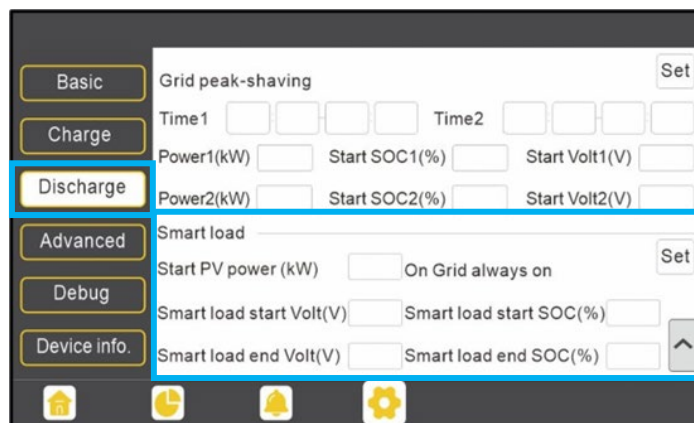

Smart Load: This function will make the GEN input connection point to a load connection point. If enabled, the inverter will supply power to this load when the battery SOC and PV power are above user set values.

For Example:

*Start PV power=1kW
Smart load start SOC= 90%
Smart load end SOC= 85%
means:*

When the PV power exceeds 1000W, and the battery system SOC gets to 90%, the Smart Load Port (GEN) will automatically switch on to power the connected load. When the battery reaches SOC<85% or PV power<1000W, the Smart Load Port automatically switches off.



Important Note:

IF THE SMART LOAD FUNCTION IS ENABLED, A GENERATOR CANNOT BE CONNECTED AT THE SAME TIME; OTHERWISE, THE DEVICE WILL BE DAMAGED!

11.2 RAPID SHUTDOWN (RSD)

The inverter includes a rapid shutdown system that complies with 2017 and 2020 NEC 690.12 requirements. A rapid shutdown switch should be connected to the RSD terminals on the master inverter and mounted in a readily accessible location outdoors (*check with the AHJ for specific requirements*). For paralleled systems, the RSD needs only to connect to the master inverter. When the switch is engaged, it will shut down all inverters in parallel.



NOTE:

When using supported EG4® batteries in closed-loop communications with the inverter, the RSD also initiates ESS Disconnect.

The system can utilize an External E-Stop Switch if the AHJ deems it necessary.

Type of External E-Stop Switch for RSD Requirements:

The external switch must have normally closed contact type for emergency shutdown.



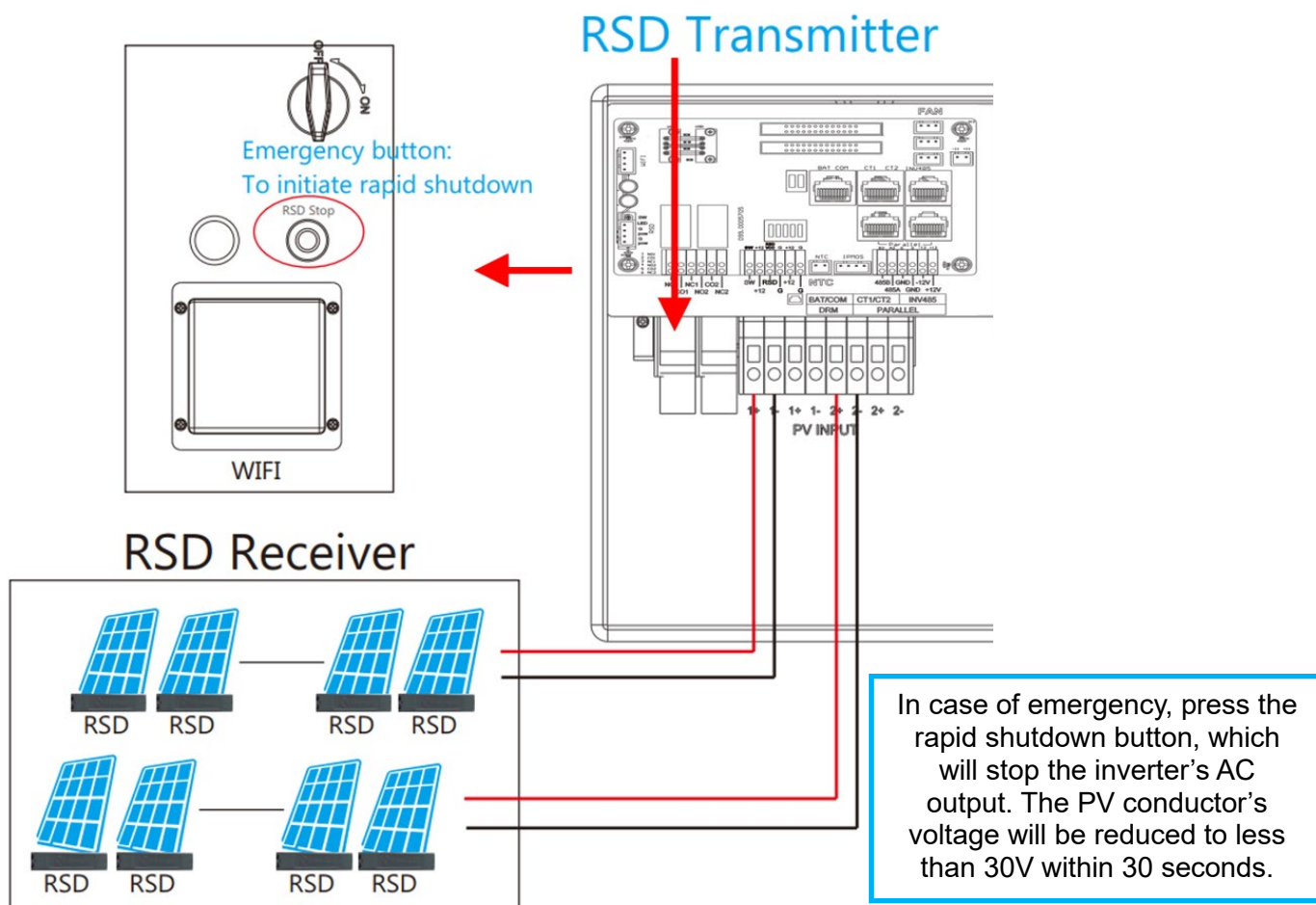

If needing to install a different RSD transmitter or for additional information on the APsmart RSD transmitter, scan the QR code below.

APsmart RSD Transmitter Module Removal



11.3 LCD DISPLAY AND SETTINGS

Users can wake up the LCD screen by simply pressing the Enter button. System status, real-time power, and daily/accumulated energy information can all be conveniently viewed on the inverter's LCD screen. Additionally, users can also check the alarm and fault record on the display for troubleshooting.

LED	Display	Description	Action
Green LED	Solid lit 	Working normally	No action needed
	Flashing 	Firmware upgrading	Wait until update is complete
Yellow LED	Solid lit 	Warning, inverter may stop working	Needs troubleshooting
Red LED	Solid lit 	Fault, inverter will stop working	Needs troubleshooting











DISPLAY BUTTON	FUNCTION
Return	Exit
Up	Previous Level, Increase
Down	Next Level, Decrease
Enter	Confirm, Enter Menu

Viewing Information and Alarm Fault/Record





Home Screen

Connect in: xxx S

Touch the LCD screen to bring it out of sleep mode. The home page will appear on the display. Users will see a system overview diagram along with real-time information of each component such as battery SOC, battery charging/discharging power, grid import/export power, load power, etc. On the right side of the screen, users can check daily and accumulated solar energy, battery charge/discharge energy, grid import/export energy, as well as load consumption.

PV Energy	
Today:	
Total:	
Charge Energy	
Today:	
Total:	
Export	
Today:	
Total:	
Consumption	
Today:	
Total:	

LCD Version :

Detailed System Information

Click on the pie icon at the bottom of the screen to view the detailed real-time solar information, battery information, grid information, and load output information.

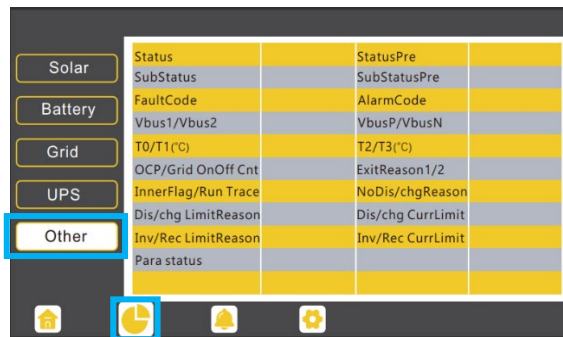
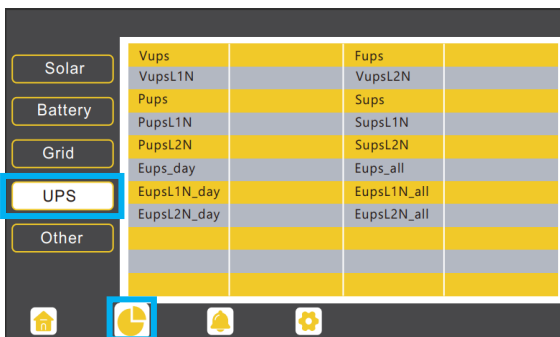
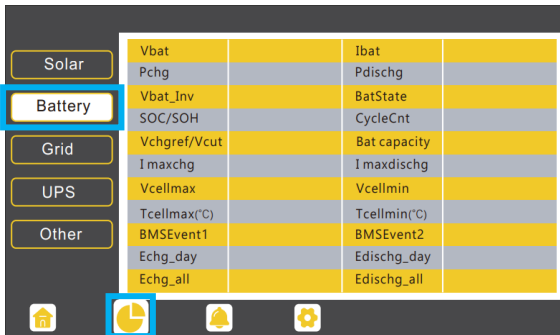

11.4 SETTING PARAMETERS

Click on the gear icon at the bottom of the screen to get into the parameter setting page for the inverter. If prompted during setting changes, enter “0000” as the password.

Basic Settings

Standby: This setting is for users to set the inverter to normal or standby status. In standby status, the inverter will stop any charging, discharging, or solar feed-in operations.

Restart Inverter: This selection restarts the system. Note the power will be interrupted when the unit is restarted.

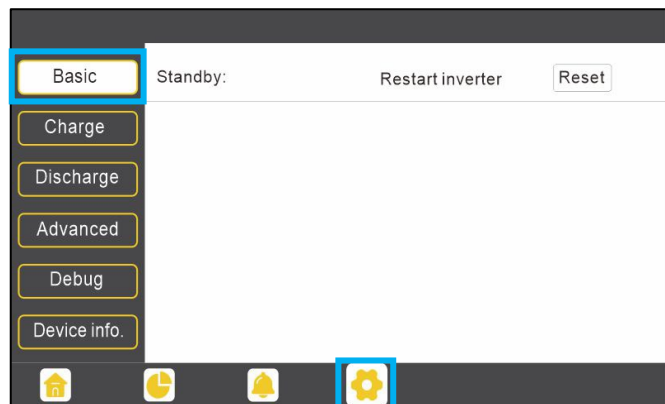

Charge Settings

Operating Mode: Users can decide to use state of charge (SOC) or battery voltage (Bat V) to control charge and discharge logic depending on battery type.

Bat. charge current limit (A): Users can set the maximum charge current.

AC Charge: If users want to use grid power to charge their battery, then they can enable **“AC Charge”** and set up to three different time periods when AC charging can happen. Set **“AC charge power (kW)”** to limit utility charging power.

Set **“Stop AC Charge SOC (%)”** as the target SOC for utility charging or **“Stop AC charge Volt (V)”** as the target battery voltage for utility charging.

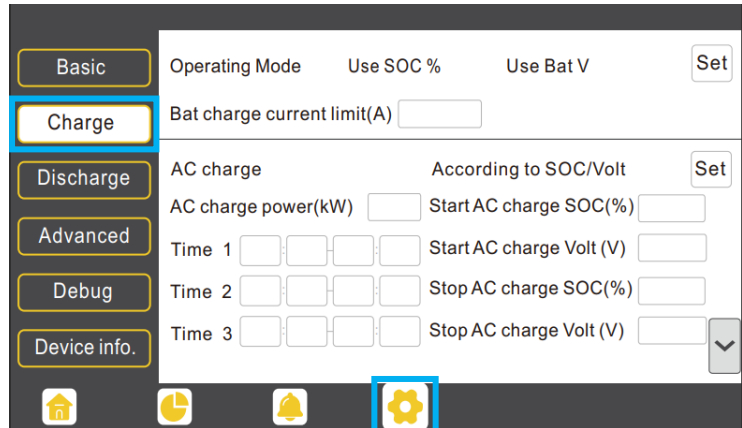

Charge first (PV): PV charge configuration. When using **“Charge first”**, PV will charge the battery as the priority. Users can set up to three different time periods when PV charge can happen.

Charge first power (kW): Limits PV charge power.

Stop charge first SOC (%): The target SOC for PV charge first.

Stop charge first Volt(V): The target battery voltage for PV charge first.

Lead-Acid: When using a Lead-Acid battery, users need to set parameters in these programs. Follow the battery manufacturer’s recommendation for these settings.

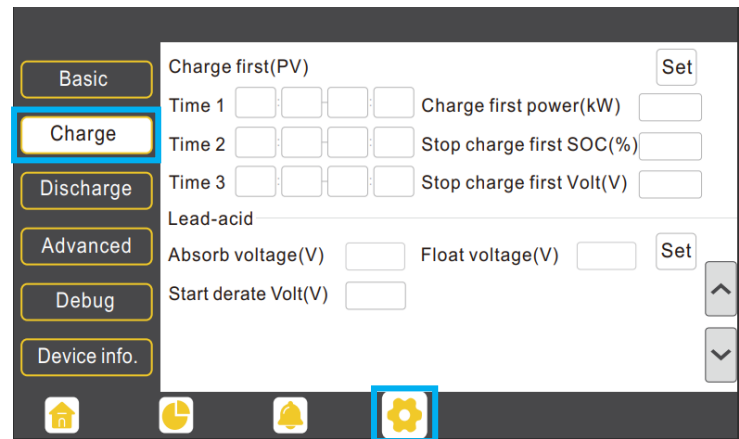

Generator

Charge current limit(A): Maximum battery charge current from the generator. The generator will start charging according to the **“Charge start Volt/SOC”** and stop charging when the battery voltage or SOC reaches the **“Charge end Volt/SOC”** value.

Gen rated power(kW): The inverter has a peak-shaving function. Users can enable it and set up the Gen peak-shaving power with this setting.

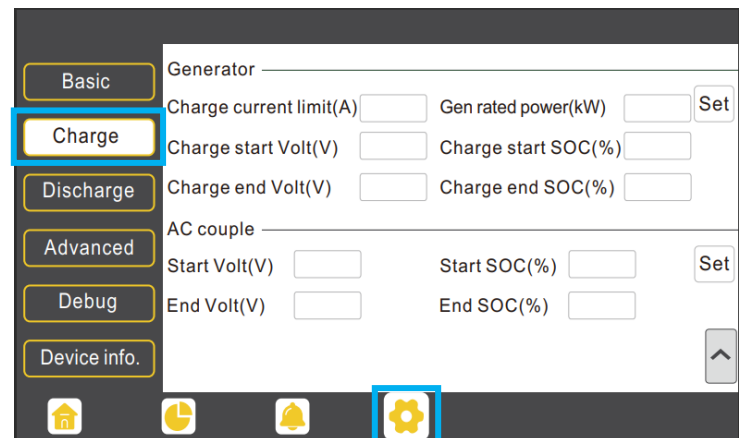

Discharge Settings

Operating Mode: Users can choose **“Use SOC %”** or **“Use Bat V”** to control the battery discharge state.



NOTE:

When using EG4® batteries with the 12kPV inverter, it is recommended to set the cut-off SOC to 20% to maintain the 80% Depth of Discharge (DOD).

Discharge current limit(A): The maximum discharge current from the battery.

Discharge start power(W): The minimum value can be set to 50. When the inverter detects the import power is higher than this value, the battery starts discharging; otherwise, the battery will stay in standby.

On-grid Cut-off (%), Off-grid Cut off (%) / On-grid Cut-off(V), Off-grid Cut off(V): End of discharge SOC/Cutoff voltage when the system is in an on-grid or off-grid situation, respectively.

Forced discharge: This setting will force the battery to discharge within the programmed period. In the programmed period, the inverter will discharge the battery at the power set by **“Discharge power(kW)”** until battery SOC or voltage reaches **“Stop discharge”** value.

Basic	Operating Mode	Use SOC %	Use Bat V	Set
Charge	Discharge current limit(A)	<input type="text"/>	Discharge start power(W)	<input type="text"/>
Discharge	On-grid Cut-off(%)	<input type="text"/>	Off-grid Cut-off(%)	<input type="text"/>
Advanced	On-grid Cut-off(V)	<input type="text"/>	Off-grid Cut-off(V)	<input type="text"/>
Debug	Forced discharge	Set		
Device info.	Time1	<input type="text"/>	Discharge power(kW)	<input type="text"/>
	Time 2	<input type="text"/>	Stop discharge SOC(%)	<input type="text"/>
	Time 3	<input type="text"/>	Stop discharge Volt(V)	<input type="text"/>



IMPORTANT:

The following settings may need to be adjusted by the installer after installation. Consult with your installer/distributor before making any changes to avoid conflicting settings or damage to your system!

Advanced Settings

Grid type: The user can choose 240/120V or 220/208V.

Grid Regulation: Select the correct grid safety regulation.

Grid Frequency: If the grid frequency is nominal at 50Hz, then the inverter's frequency will be adjusted to 50Hz automatically. If there is no grid power and it is read as 50Hz but the devices are 60Hz, then the user can set to 60Hz manually. This is based on the rated frequency of the local grid regulation and devices.

Battery type: No battery, Lead-acid, or Lithium.

If **“Lead-acid”** battery is selected, input the correct battery capacity.

If **“Lithium”** battery is selected, choose the battery's brand in the Lithium brand drop-down list.

Meter type: Choose setting according to the meter installed.

CT ratio: The supported CT ratio is 1000:1, 2000:1, and 3000:1. The default CT ratio is 3000:1. If a third-party CT is used, ensure the CT ratio is one of the three supported types and set it accordingly.

Off-grid output: Enabling this setting will cause the inverter to provide backup power if the grid is lost.

“Seamless switch” must be enabled if users want the load to be transferred seamlessly to the inverter backup power.

“No Battery” can be enabled to use solar power to supply load when the grid fails or load-shedding happens. If users do not have a battery installed yet but still wish to have inverter backup power with only solar panels connected, this setting can be enabled.

“Micro-grid” should be set **only** when the generator is connected to the inverter's Grid terminal. With this option enabled, the inverter will use AC power to charge the battery and will not export any power through the Grid terminal if AC power is present at the inverter's Grid terminal.

“Charge last” will use solar power in the following order: Loads>Grid export>Battery charging.

“CT direction reversed” occurs when both CTs are installed in the wrong direction; the installer can remedy this by checking this box.



CAUTION:

Zero Export cannot prevent export of energy supplied by inverters that are AC Coupled to the 12kPV.

Export to Grid: This selection is for users to set a zero-export function. If exporting solar power is not allowed, users need to disable the “**Export to Grid**” option. If a user’s utility meter is tripped with minimal solar export, “**Zero Export**” can be enabled, thus the export detection and adjustment will take place every 20 ms, which will effectively avoid any power being exported. If export is allowed, users can enable “**Export to Grid**” and set a maximum allowable export limit in “**Max Export to Grid(kW)**”.

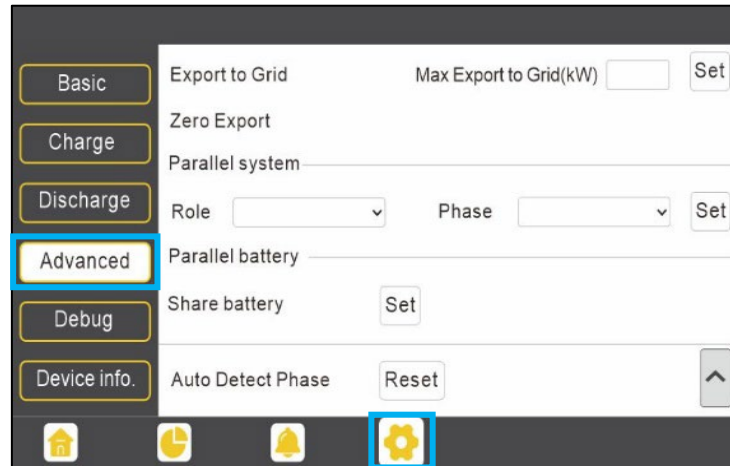

Parallel System

“**Role**” setting of the parallel system. It is set to “*1 phase master*” by default. In a parallel system, only one inverter is allowed to be set as Master and the others are set as Slaves.

“**Phase**” is the phase code setting of the load output. The system will automatically detect the phase sequence of the inverter (consistent with the phase sequence of the connected grid mains) and display it on the inverter after it is connected to the grid.

Share battery: If all inverters are connected to the same battery bank when configured as a parallel system, then this setting must be **enabled**. If the inverters are configured as a parallel system and are connected to independent battery banks, then this setting must be **disabled**.



REMINDER:

All setting changes for parallel inverters must be done while in Standby Mode. If the system is connected to a Lithium battery, the host of the battery bank needs to communicate with the inverter that is set as Master in the parallel system. Keep all the settings the same for each inverter in the parallel system on the LCD or remote monitor!

12. OPERATING MODES

The EG4® 12kPV can work in several different modes of operation:

- **Self-Consumption Mode:** The inverter will operate in a pre-set priority system. In this mode, the user will experience the inverter drawing power from the solar arrays to power the loads, this is the default operating mode. When the solar power is insufficient, the inverter will then draw from the battery bank for loads. Only as a last resort will the inverter switch to bypass mode to power loads from AC input.
- **Battery Backup Mode:** The inverter will operate in a pre-set priority system. In this mode, the user will experience the inverter drawing power from the solar arrays to power the loads. When/if the solar power is insufficient, the inverter will then switch to bypass mode to power loads from AC input. The inverter will only power loads with battery when there are no other options.
- **Grid Sell Back with AC Couple:** The inverter will operate with full functionality while still allowing the inverter to sell back to the grid using the GEN port for an AC coupled system.

12.1 SELF-CONSUMPTION MODE

Ensure the inverter is in standby mode before making any changes to the system settings.

Listed below are the combination of settings to achieve Self-Consumption Mode via the mobile app or monitoring website for single inverter operations.



NOTE:

Ensure settings match the below selections. If any settings are missing from the list below, contact the distributor for more information regarding commissioning.

1. Step 1

PV Input Mode	7: PV1&2&3 in	Set
---------------	---------------	-----

2. Step 2

Grid Sell Back	Enable	Disable
----------------	--------	---------

3. Step 3

Fast Zero Export	Enable	Disable
------------------	--------	---------

4. Step 4

Run Without Grid	Enable	Disable
------------------	--------	---------

5. Step 5

Seamless EPS switching	Enable	Disable
------------------------	--------	---------

6. Step 6

On-Grid Cut-Off SOC(%) (?)	25	Set
----------------------------	----	-----

7. Step 7

Charge Current Limit(Adc)	100	Set
---------------------------	-----	-----

8. Step 8

Discharge Current Limit(Adc) (?)	100	Set
----------------------------------	-----	-----

12.2 BATTERY BACKUP MODE

Ensure the inverter is in standby mode before making any changes to the system settings.

Listed below are the combination of settings to achieve Battery Backup Mode via the mobile app or monitoring website.



NOTE:

Ensure settings match the below selections. If any settings are missing from the list below, contact the distributor for more information regarding commissioning.

1. Step 1

PV Input Mode	7: PV1&2&3 in	Set
----------------------	---------------	-----

2. Step 2

Grid Sell Back	Enable	Disable
-----------------------	--------	---------

3. Step 3

Fast Zero Export	Enable	Disable
-------------------------	--------	---------

4. Step 4

Run Without Grid	Enable	Disable
-------------------------	--------	---------

5. Step 5

Seamless EPS switching	Enable	Disable
-------------------------------	--------	---------

6. Step 6

AC Charge Enable	Enable	Disable
-------------------------	--------	---------

7. Step 7

Charge Current Limit(Adc)	100	Set
----------------------------------	-----	-----

8. Step 8

Start AC Charge SOC(%)	<input type="text" value="90"/>	<input type="button" value="Set"/>
Stop AC Charge SOC(%)	<input type="text" value="100"/>	<input type="button" value="Set"/>

9. Step 9

AC Charge Start Time 1	<input type="text" value="00"/>	:	<input type="text" value="01"/>	<input type="button" value="Set"/>
AC Charge End Time 1	<input type="text" value="23"/>	:	<input type="text" value="59"/>	<input type="button" value="Set"/>

10. Step 10

Battery Priority (?)	<input type="button" value="Enable"/>	<input type="button" value="Disable"/>
----------------------	---------------------------------------	--

11. Step 11

On-Grid Cut-Off SOC(%) (?)	<input type="text" value="90"/>
----------------------------	---------------------------------

12. Step 12

Discharge Current Limit(Adc) (?)	<input type="text" value="100"/>	<input type="button" value="Set"/>
----------------------------------	----------------------------------	------------------------------------

12.3 GRID SELL BACK WITH AC COUPLE

Ensure the inverter is in standby mode before making any changes to the system settings. To achieve Grid Sell Back w/ AC Couple working mode, refer to the following settings.



NOTE:

Ensure settings match the below selections. If any settings are missing from the list below, contact the distributor for more information regarding commissioning.

1. Step 1

PV Input Mode	7: PV1&2&3 in	Set
----------------------	---------------	-----

2. Step 2

Run Without Grid	<input checked="" type="button" value="Enable"/>	<input type="button" value="Disable"/>
-------------------------	--	--

3. Step 3

Seamless EPS switching	<input checked="" type="button" value="Enable"/>	<input type="button" value="Disable"/>
-------------------------------	--	--

4. Step 4

Battery Priority (?)	<input type="button" value="Enable"/>	<input checked="" type="button" value="Disable"/>
-----------------------------	---------------------------------------	---

5. Step 5

Charge Current Limit(Adc)	100	Set
----------------------------------	-----	-----

6. Step 6

AC Couple	<input checked="" type="button" value="Enable"/>	<input type="button" value="Disable"/>
------------------	--	--

7. Step 7

AC Couple Start SOC(%)	25	Set
AC Couple End SOC(%)	100	Set

9. Step 8

Discharge Current Limit(Adc) (?)	100	Set
----------------------------------	-----	-----

10. Step 9

On-Grid Cut-Off SOC(%) (?)	25	Set
----------------------------	----	-----

13. DOUBLE CHECK ALL WIRING/VOLTAGES/AMPS

Once all settings are configured to achieve the desired mode, check all voltages at all available disconnects as an added safety step before outputting power from the inverter. Ensure all circuit breakers are open (off). Using a multimeter, check voltages at all available disconnects. Once 0V on all lines are confirmed, proceed to full system start-up.

14. FULL SYSTEM START-UP

Follow the steps listed below for proper start-up sequence of the inverter:

1. If equipped, first close (turn on) the external DC breaker between the battery and inverter. Turn on the "BAT" breaker located in the cable box of the inverter and then power on the battery system.
2. Ensure the PV string voltages are within the operating parameters using a multimeter. Upon confirmation, turn on (close) the PV isolator switch between the inverter and the panel array.
3. Turn on (close) the PV isolator switch on the side of the unit.
4. Make sure Steps 1 and 2 are accomplished before turning on the grid power or generator breaker.
5. Power on the load breakers on the inverter.

15. FULL SYSTEM SHUTDOWN

Follow the steps listed below for proper shutdown sequence of the inverter:

1. Turn off (open) the grid breaker feeding the inverter.
2. Turn off the LOAD breaker.
3. Turn off the PV isolator switch.
4. Turn off the BAT breaker.

Once the LCD powers down, the inverter has been shut down.

16. INVERTER TROUBLESHOOTING

See the troubleshooting information in the tables below when encountering any faults and/or errors on the inverter.

16.1 VIEWING INFORMATION AND ALARM FAULT/RECORD

Home Screen

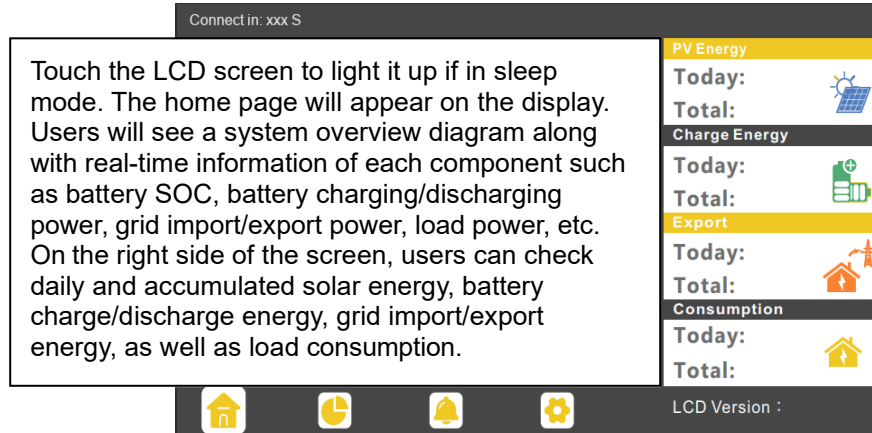

Fault/Alarm Information

By touching the bell icon at the bottom of the screen, users will see all the current and historical faults and warning information on this page.

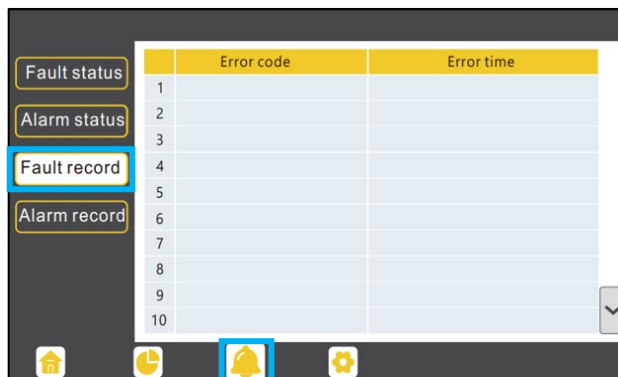
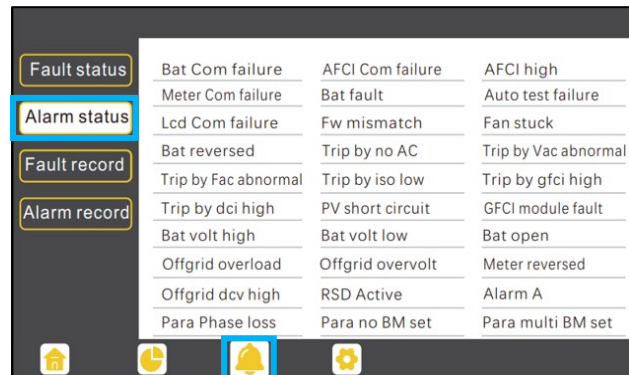
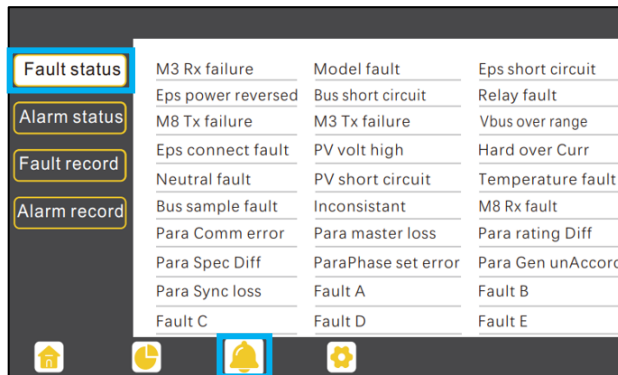

16.2 REGULAR MAINTENANCE

Inverter Maintenance

- Inspect the inverter every 6 months to check for any damaged cables, accessories, or terminals, and inspect the inverter itself.
- Inspect the inverter every 3 months to verify the operating parameters are normal and there is no abnormal heating or noise from all components in the system.
- Inspect the inverter every month to confirm nothing covers the inverter heat sink. If there is, shut down the inverter and clear the heat sink to restore proper cooling.

16.3 TROUBLESHOOTING BASED ON LCD SCREEN

Once there is any warning or fault occurring, users can troubleshoot according to the LED status description and the warning/fault information on the LCD screen.

Faults on the LCD and Fault List

If the dot on the left of the fault item is **red**, it means the fault is active.

When the dot is grey, it means the fault is inactive.

FAULT	MEANING	TROUBLESHOOTING
M3 Rx failure	M3 microprocessor fails to receive data from DSP	Restart the inverter. If the error persists, contact the distributor.
Model fault	Incorrect model value	Restart the inverter. If the error persists, contact the distributor.
EPS short circuit	Inverter detected short-circuit on load output terminals	<ol style="list-style-type: none"> 1. Check if the L1, L2, and N wires are connected correctly at the inverter load output terminal. 2. Disconnect the load breaker to see if fault remains. If the fault persists, contact the distributor.
EPS power reversed	Inverter detected power flowing into load terminal	Restart the inverter. If the fault persists, contact the distributor.
Bus short circuit	DC Bus is short circuited	
Relay fault	Relay abnormal	
M8 Tx failure	DSP fails to receive data from M8 microprocessor	
M3 Tx failure	DSP fails to receive data from M3 microprocessor	
Vbus over range	DC Bus voltage too high	Ensure the PV string voltage is within the inverter specification. Also, check inverter and battery voltage. If voltage readings are within range and this fault persists, contact the distributor.

EPS connect fault	Load terminal and grid terminal are wired incorrectly or reversed	Check if the wires on load terminal and grid terminal are wired correctly. If the fault persists, contact the distributor.
PV volt high	PV voltage is too high	Check if the PV string voltage is within the inverter specification. If string voltage is within range and this fault persists, contact the distributor.
Hard over curr	Hardware level over current protection triggered	Restart the inverter. If the fault persists, contact the distributor.
Neutral fault	Voltage between N and G is greater than 30V	Ensure the neutral wire is connected correctly.
PV short circuit	Short circuit detected on PV input	Disconnect all PV strings from the inverter. If the error persists, contact the distributor.
Temperature fault	Heat sink temperature too high	Install the inverter in a place with good ventilation and no direct sunlight. If the installation site is okay, check if the NTC connector inside the inverter is loose.
Bus sample fault	Inverter detected DC bus voltage lower than PV input voltage	Restart the inverter, if the fault persists, contact the distributor.
Inconsistent	Sampled grid voltage values of DSP and M8 microprocessor are inconsistent	
M8 Rx fault	M8 microprocessor fails to receive data from DSP	
Para Comm error	Parallel communication abnormal	<ol style="list-style-type: none"> 1. Verify the parallel cable is plugged into the proper ports and the connections are not loose. 2. Ensure the PIN status of the CAN communication cable from the first to the end inverter is configured correctly.
Para master loss	No Master in the parallel system	<ol style="list-style-type: none"> 1. If a Master has been configured in the system, the fault will automatically be removed after the Master works. 2. If a Master has not been configured and there are only Slaves in the system, set the Master first. Note: For a single-unit system, the role of the inverter should be set as "1 phase Master."
Para rating Diff	Rated power of parallel inverters is inconsistent	Confirm that the rated power of all inverters is the same.
Para Phase set error	Incorrect setting of phase in parallel	First confirm the wiring for the parallel system is correct. Once verified, connect each inverter to the grid. The system will automatically detect the phase sequence and the fault automatically resolves after the phase sequence is detected. If the fault persists, contact the distributor.
Para Gen in Accord	Inconsistent generator connection in parallel	Some inverters are connected to generators, and some are not. Confirm <i>all</i> inverters in parallel are connected to common generator output, or <i>none</i> are connected to generators.
Para sync loss	Parallel inverter fault	Restart the inverter. If the fault persists, contact the distributor.

Alarm on the LCD and Alarm List

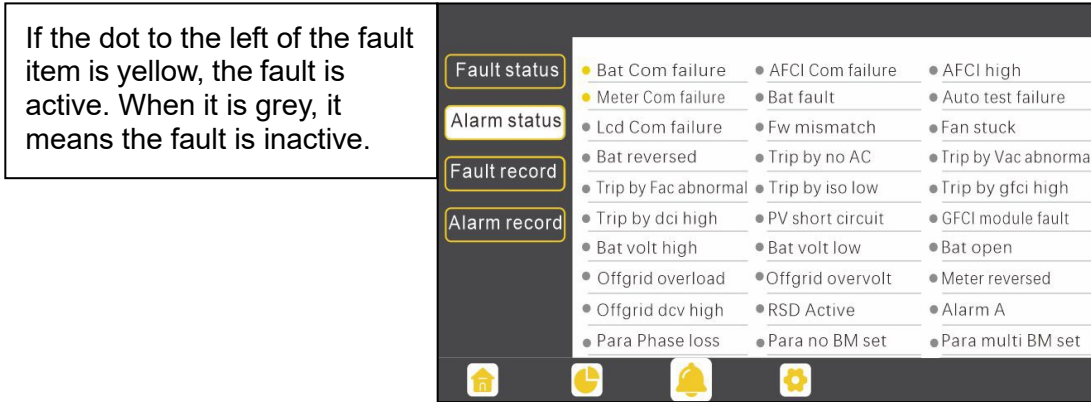

Alarm List

ALARM	MEANING	TROUBLESHOOTING
Bat com failure	Inverter fails to communicate with battery	Check if the communication cable pinout is correct, and if the correct battery brand is selected on the inverter's LCD. If all is correct but the alarm persists, contact the distributor.
AFCI com failure	Inverter fails to communicate with AFCI module	Restart inverter. If the error continues, contact the distributor.
AFCI high	PV arc fault is detected	Check each PV string for correct open-circuit voltage and short-circuit current. If the PV strings are in good condition, clear the alarm on the inverter LCD.
Meter com failure	Inverter fails to communicate with the meter	Check if the communication cable is connected correctly and in good working condition. Restart inverter. If the alarm persists, contact the distributor.
Bat Fault	Battery cannot charge or discharge	<ol style="list-style-type: none"> 1. Check the battery communication cable for correct pinout on both inverter and battery end. 2. Check if an incorrect battery brand is selected. 3. Check if there is fault on battery's indicator. If there is a fault, contact the battery distributor.
LCD com failure	LCD fails to communicate with M3 microprocessor	Restart inverter. If the alarm persists, contact the distributor.
Fwm mismatch	Firmware version mismatch between the microprocessors	
Fan stuck	Cooling fan(s) are stuck	
Trip by GFCI high	Inverter detected leakage current on AC side	<ol style="list-style-type: none"> 1. Check if there is ground fault on grid and load side. 2. Restart inverter. If the alarm persists, contact the distributor.
Trip by dci high	Inverter detected high DC injection current on Grid terminal	Restart inverter. If the alarm persists, contact the distributor.

PV short circuit	Inverter detected a short circuit in PV input	<ol style="list-style-type: none"> 1. Check whether each PV string is connected correctly. 2. Restart inverter. If the alarm persists, contact the distributor.
GFCI module fault	GFCI module is abnormal	Restart inverter. If the alarm persists, contact the distributor.
Bat volt high	Battery voltage too high	Check whether the battery voltage exceeds 59.9V; battery voltage should be within inverter specification.
Bat volt low	Battery voltage too low	Check whether the battery voltage is under 40V; battery voltage should be within inverter specification.
Bat open	Battery is disconnected from inverter	Check battery breaker or battery fuse. Reconnect as needed.
Off-grid overload	Overload on Load terminal	Check if load power on inverter LOAD terminal is within inverter specification.
Off-grid overvolt	Load voltage is too high	Restart inverter. If the alarm persists, contact the distributor.
Meter reversed	Meter connection is reversed	Check if the meter communication cable is connected correctly on the inverter and meter sides.
Off-grid dcv high	High DC voltage component on load output when running off-grid	Restart inverter. If the alarm persists, contact the distributor.
RSD Active	Rapid shutdown activated	Check if the RSD switch is pressed.
Para phase loss	Phase losing in parallel system	Confirm that the wiring of the inverter is correct. If the Master is set to 3-phase Master, the number of parallel inverters must be ≥ 3 . (The grid input for each inverter should be connected correctly to Grid L1, L2, L3.) If the Master is set to 2x 208 Master, the number of parallel inverters needs to be ≥ 2 . (And the grid input of each inverter should be connected correctly to Grid L1, L2, L3.)
Para no BM set	Master is not set in the parallel system	Set one of the inverters in the parallel system as the Master.
Para multi BM set	Multiple Primaries have been set in the parallel system	There are at least two inverters set as the Master in the parallel system. Keep one Master and set the other as Slave.

17. TROUBLESHOOTING WI-FI MODULE

17.1 CENTER LIGHT FLASHING

Why is the middle light for the Wi-Fi module flashing?

After setting the right Wi-Fi password, all three lights should be on solidly. If it is still flashing, try the following:

1. Check to see if the Wi-Fi is connected and that the correct password has been entered. The device can be used to connect to a Wi-Fi hotspot and visit the website 10.10.10.1 to check; the TCP client status should be "connected" as seen in the image. The login username and password are both "admin." Check the Wi-Fi name and password if it is.
2. Prior to setting the password, add the dongle to the system. After registering and entering the Wi-Fi SN and PIN, this dongle is automatically added to the system. While logged in, go to "Configuration">"Dongles">"Add dongle" on <https://monitor.eg4electronics.com/> to add this dongle to the current configuration if the user has more than one dongle. Restart the Wi-Fi module by unplugging it and plugging it back in after installing the dongle.

10.10.10.1

Run State

- Wifi Mode Select
- AP Mode Setting
- Station Mode Setting
- Uart Setting
- Network Setting
- Moduel Manangement

AP State

Function	Enable
IP	10.10.10.1
Netmask	255.255.255.0

STA State

Function	Enable
Channel	6
Signal Strength	-46%
IP	192.168.0.146
Netmask	255.255.255.0
Gateway	192.168.0.1

Command Mode State

Function	Disable
----------	---------

Network 1 State

Function	Enable
Protocol	TCP client
TCP Client State	Connected

Serial number	Dongle type	Station name	EndUser	Firmware	Create date	Connect Status	Last Update Time	Action
1	Wi-Fi		EndUser		2023-08-11	Lost	2024-01-18 13:05	Management
2					2023-09-22	Lost		Management
3	Wi-Fi				2023-08-02	Lost	2023-08-15 14:34	Management
4					2024-03-03	Lost		Management
5	Wi-Fi				2023-10-13	Connected	2024-03-07 14:22	Management

17.2 DONGLE RECOVERY

This section will detail the steps needed to recover Wi-Fi dongles with serial numbers starting with the letters "BA" after being reset to factory settings.

Read the section in its entirety before performing the steps listed below:

Step 1

Connect the dongle to the inverter's Wi-Fi dongle port as shown below.

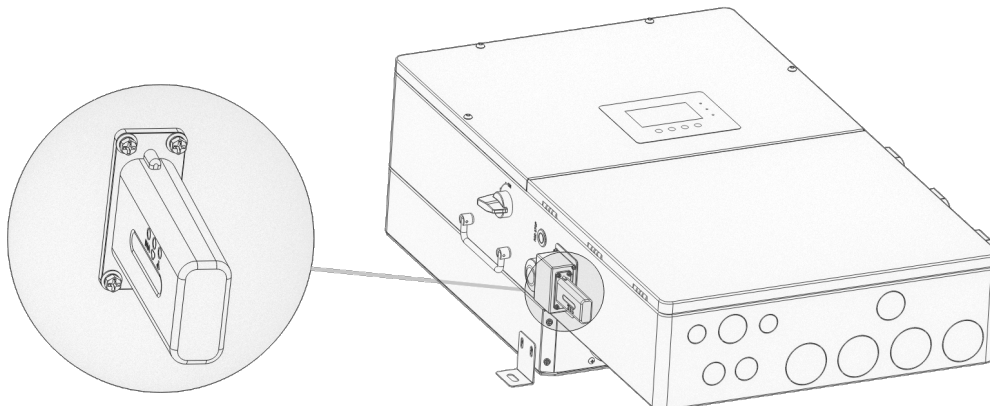

Step 2

After ~30 seconds, the dongle's LED status will appear as shown below.

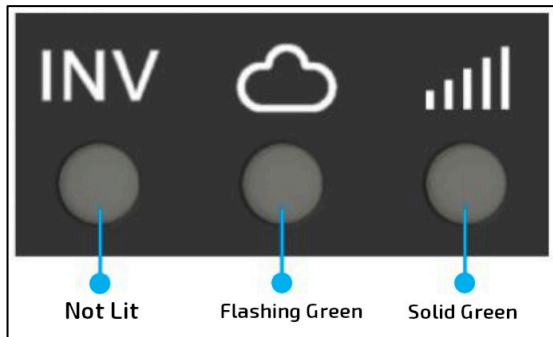

- INV LED “OFF”
- Network LED “Blinking”
- Module LED “ON”

Step 3

Connect the mobile device/PC to the dongle's network. The network name will match the serial number (SN) on the outer shell of the dongle. If unable to locate the network named after the SN, check for a network named, “MXCHIP-xxxxxxx”. Write this number down for step 6.

Step 4

Enter “10.10.10.1” (no quotes) into the browser. Both the username and the password are “admin” (no quotes). After logging in, select the language on the right side. See *image below*.



Step 5

Select the “Wifi Mode Select” option on the left-hand side of the screen. From here, select “AP and Station” and “save”. See image below.

MiCO IoTOS • 中文|English

Run State

Wifi Mode Select

AP Mode Setting

Station Mode Setting

Uart Setting

Network Setting

Moduel Management

Wifi Mode Select

AP Mode

Station Mode

AP and Station

save

Step 6

Next, select the “AP Mode Setting” on the left-hand side of the screen. Enter the dongle’s SSID and select “save”. The SSID will match the dongle’s SN or “MXCHIP-xxxxxx” as determined by step 3 above. See image below.

MiCO IoTOS • 中文|English

Run State

Wifi Mode Select

AP Mode Setting

Station Mode Setting

Uart Setting

Network Setting

Moduel Management

Ap Parameter Setting

SSID BA32401403

Encryption Mode Disable

save

IP Address Setting

IP 10.10.10.1

Netmask 255.255.255.0

Gateway 10.10.10.1

save

Step 7

Navigate to the “Network Setting” page. Under “Network Connection 1 Setting”, enter the following data and save.

- Protocol: TCP Client
- Remote Port: 4346
- Server Address (IP or domain) 3.101.7.137

Under “Network Connection 2 Setting”, enter the following data and save. *See image below.*

- Protocol: TCP Server
- Local Port: 8000

MiCO IoTOS • 中文|English

Run State
Wifi Mode Select
AP Mode Setting
Station Mode Setting
Uart Setting
Network Setting
Moduel Management

Network Connection 1 Setting

Protocol	TCP Client
Remote Port	4346
Server Address(ip or domain)	3.101.7.137

save

Network Connection 2 Setting

Protocol	TCP Server
Local Port	8000

save

Step 8

Navigate to the “Station Mode Setting” page. Enter the home Wi-Fi SSID information. Ensure that “Encryption Mode” is set to “Enable”. Enter in the home Wi-Fi password and select “Save”. *See image below.*

MiCO IoTOS • 中文|English

Run State
Wifi Mode Select
AP Mode Setting
Station Mode Setting
Uart Setting
Network Setting
Moduel Management

Station Parameter Setting

SSID		scan
Encryption Mode	Enable	
Password		save

IP Setting

Auto	DHCP Client
IP	
Netmask	255.255.255.0
Gateway	

save

18. WARRANTY INFORMATION

For information regarding warranty registration on EG4® Electronics products, please navigate to <https://eg4electronics.com/warranty/> and select the corresponding product to begin the registration process.

CHANGELOG

Version 1.2.5

- Modified max AC input power from 12000 to 8000W
- Modified minimum installation spacing requirements from 200 mm to 125 mm
- Added French warning/danger safety section
- Added Locked Rotor Amps (LRA) value to spec sheet

Version 1.2.4

- Modified cable string length for PV, AC and Battery
- Removed (Pending) from FCC certification

Version 1.2.3

- Added cable box knockout dimensions image

Version 1.2.2

- Modified warranty information

Version 1.2.1

- Updated warranty information
- Added California Prop 65 label to safety section

Version 1.2

- Modified safety information for consistency
- Changed verbiage throughout document for clarity
- Modified structure of document for readability
- Modified Sec. 4 Packing List.
- Added inverter location and angle images to Sec. 5.1.
- Added mounting bracket image to Sec. 5.3.
- Modified Sec. 5.4 for clarity and consistency.
- Modified Sec. 6.2 for consistency.
- Modified list in Sec. 6.3 for consistency.
- Added image for Battery Communications to Sec. 6.4.
- Modified list in Sec. 7 for consistency.
- Added Note quick-part in Sec. 7 for clarity.
- Modified Sec. 10.1 for clarity.
- Modified Sec. 10.1 images for clarity.
- Modified Smart Load in Sec. 10.1 for clarity.
- Modified Sec. 10.2 and added APsmart QR code for clarity.
- Added Display button table to Sec. 10.3.
- Modified Sec 10.4 for clarity.
- Modified Sec. 11 for consistency.
- Modified Sec. 15 for clarity.

- Modified table in Sec. 15.3 for consistency.



CONTACT US

support@eg4electronics.com

(903) 609-1988

www.eg4electronics.com