

PP18

POWERPROTECT
Standby Generators



RESIDENTIAL Standby Generators



SPECIFICATIONS

OVERVIEW	
Brand	Briggs & Stratton
Series Name	PowerProtect™
Model Name	PP18
Power, Standby (LP/NG) (kW)	18 / 18
Rated AC Voltage (Volts)¹	120 / 240
Rated Frequency (Hz)¹	60
Generator Breaker (Amps)	80
Operating Ambient Temperature (°C / °F)	-28 to 40 / -20 to 104
Rated Amperage, Standby (LP/NG) (Amps)¹	75.0 / 75.0
Rated Power Factor	1.0
Programmable Exercise Cycle	16 sec (default) - 20 mins
Engine	
Engine Brand/Manufacturer	Vanguard
Model Type	M61
Aspiration	Naturally Aspirated
Speed (RPM)	3600
Displacement (ci/cc)	61 / 993
Compression Ratio	9.7:1
Governor Type	SAE J1444 Class B Frequency Regulation
Bore & Stroke (in/mm)	3.37 x 3.41 / 85.5 x 86.5
Cylinder Block	Aluminum w Cast Iron Sleeve
Valve Arrangement	OHV

PP18

POWERPROTECT

Standby Generators

RESIDENTIAL STANDBY GENERATORS SPECIFICATIONS



BRIGGS & STRATTON
ENERGY SOLUTIONS

Engine	
Engine Cylinder Configuration	V
Number of Cylinders	2
Start Type	Automatic, Starter Motor
Air Filter Type	Dry
Low Oil Pressure Switch	Yes
Engine Oil Heater	Available as an Accessory
Rated Temperature (°F/ °C)	77 / 25
Sound Rating	
Low Idle Mode Sound dB(A) ²	64
Normal Operating Sound dB(A) ²	68
Lubrication System	
Type	Full Pressure
Oil Capacity (oz/L)	78 / 2.31
Oil Filter (Quantity/Type)	1 / Cartridge
Oil Brand	Schaeffer
Recommended Oil	5W30 Full Synthetic
Electrical System	
Ignition System	Variable Timing
Battery Quantity	1
Battery Voltage (VDC)	12
Battery CCA (Amps)	540
Battery BCI Group Size	26 or 51
Starter Motor Voltage (VDC)	12
Fuel System	
Fuel Type	NG / LPV
Fuel Supply Line Inlet	3/4" NPT
Recommended Fuel, Lower Heating Value Minimum (MJ/m ³ / BTU/ft ³)	NG: 34.3 / 904 LPV: 87.1 / 2338
Fuel Supply Pressure (mbar/in H ₂ O)	NG: 9-17 / 3.5-7 LPV: 28-34 / 11-14
Fuel Consumption	
No Load, NG (BTU/hr)	99,000
No Load NG (ft ³ /hr)	99
Half Load, NG (BTU/hr)	176,000

PP18

POWERPROTECT

Standby Generators

RESIDENTIAL STANDBY GENERATORS SPECIFICATIONS



BRIGGS & STRATTON
ENERGY SOLUTIONS

Fuel Consumption	
Half Load, NG (ft ³ /hr)	176
Full Load, NG (BTU/hr)	252,000
Full Load, NG (ft ³ /hr)	252
No Load, LP (BTU/hr)	100,000
No Load, LP (ft ³ /hr)	40
No Load, LP (gal/hr)	1.1
Half Load, LP (BTU/hr)	193,000
Half Load, LP (ft ³ /hr)	77
Half Load, LP (gal/hr)	2.2
Full Load, LP (BTU/hr)	310,000
Full Load, LP (ft ³ /hr)	124
Full Load, LP (gal/hr)	3.5
Alternator Specifications	
Alternator Type	Synchronous, Self-Excited, Rotating Field
Alternator Manufacturer	B&S
Rated Frequency (Hz) ¹	60
Rated Phase ¹	1
Insulation Rating (Class)	H
Designed Temperature Rise (°C)	125
Bearing (Quantity/Type)	1 / Sealed
Number of Poles	2
Voltage Regulator	Brushed / Electronic
Motor Starting Capability (kVA)	45
Total Harmonic Distortion (THD), NL to FL (%)	< 5
Controls / Instrumentation	
Controller	GC-1032
Charger	Stand Alone
Starting	AMF or 2-wire
LED Display with Fault Code Indications	Yes
Real Time Clock	Yes
Engine Hour Counter	Yes
Engine Runtime Scheduler	Yes

PP18

POWERPROTECT

Standby Generators

RESIDENTIAL STANDBY GENERATORS SPECIFICATIONS



BRIGGS & STRATTON
ENERGY SOLUTIONS

Controls / Instrumentation	
Low Oil Pressure Shutdown	Yes
High Temperature Shutdown	Yes
Other Features	
Battery Rack and Cables	Yes
Fuel Solenoid Valve	Yes
Integral Vibration Isolation	Yes
Oil Drain Extension	Yes
Operation and Installation Manual(s)	Yes
Enclosure	Aluminum
Enclosure Wind Speed Rating (mph)	186
Accessories	
Maintenance Kit	6872
Oil Warmer	6840
Fuel Regulator Warmer	6845
Surge Protector	6631
InfoHub™ Universal - Cellular	6574
Limited Warranty ⁴	
Warranty: Generator, Domestic & Canada (Parts / Labor / Travel) – Years	7
Warranty: Enclosure, Surface Rust and Corrosion (Parts / Labor / Travel) – Years	1
Warranty: Enclosure, Rust Through (Parts / Labor / Travel) – Years	3
Warranty: Non-Emergency (Parts/Labor/Travel) – Years	7yr or 1000 hr
Certifications	
UL	Yes
cUL	Yes
FCC	Yes
Massachusetts Plumbers and Gasfitters	Yes
NFPA 37	18" Installation Clearance from House ⁵

PP18

POWERPROTECT

Standby Generators

RESIDENTIAL STANDBY GENERATORS SPECIFICATIONS



BRIGGS & STRATTON
ENERGY SOLUTIONS

Weights & Dimensions	
Assembled Dimensions (Length x Width x Height) (in / mm)	46.5 x 26.8 x 28.4 / 1181 x 681 x 721
Assembled Weight (lbs / kg)	465 / 210
Packaged Dimensions (Length x Width x Height) (in / mm)	48.8 x 30.5 x 50.5 / 1240 x 775 x 1283
Packaged Weight (lbs / kg)	540 / 245
Outline and Pad Layout Drawing	80104089

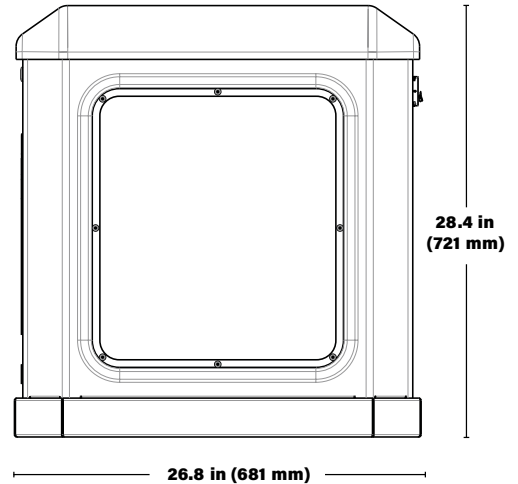
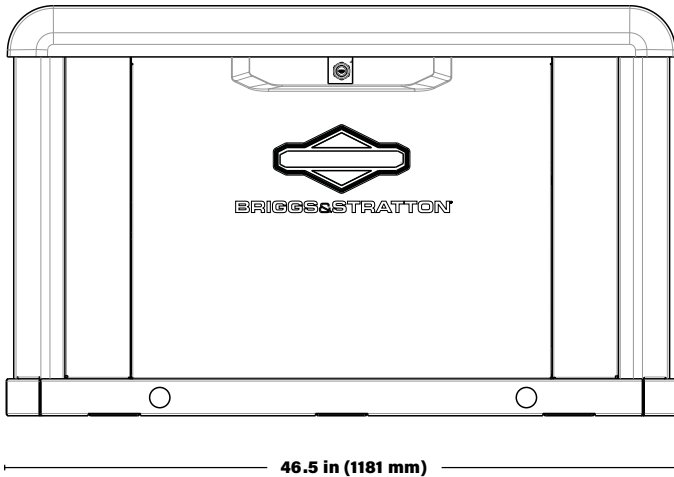

¹ This generator is rated in accordance with UL (Underwriters Laboratories) 2200 (stationary engine generator assemblies) and CSA (Canadian Standards Association) standard C22.2 No. 100-14 (motor and generators).

² Per ISO 3744. Sound level measurement at other locations around generator may differ depending on installation, based on lowest microphone at 7m. Normal operation based on average household usage.

³ Fuel consumption rates are estimated based on normal operating conditions. Generator operation may be greatly affected by elevation and the cycling operation of multiple electrical appliances — fuel flow rates may vary depending on these factors.

⁴ See operator's manual or energy.briggsandstratton.com for complete warranty details.

⁵ Listing and labeling to NFPA 37 per Southwest Research Institute.

Briggs & Stratton has a policy of continuous product improvement and reserves the right to modify its specifications at any time and without prior notice.

This standby generator is not for Prime Power applications.

Please visit energy.briggsandstratton.com for the latest information.

BS1452 - 04/18/24

BRIGGS & STRATTON
POST OFFICE BOX 702
MILWAUKEE, WI 53201 USA

Copyright © 2024 Briggs & Stratton. All rights reserved.